



BL-1855



Three color temperature adjustment , Touch stepless dimming , With USB socket

BL-1855



Power: 8W LED (included)

Voltage: AC100-240V, DC13.5V

Colour Temp: 3000K-4000K-6000K

Lumen: 480 Max

CRI: ≥80a



Black Grey

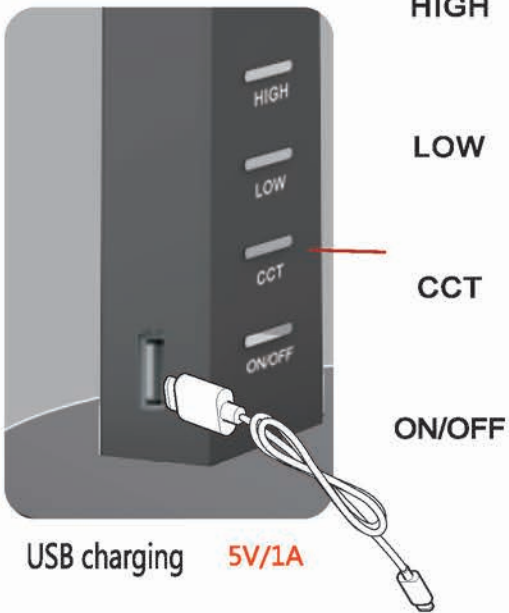

USB charging 5V/1A

The USB socket can be used for charging your phone, camera, pad and laptop.



Copper



Silver White

Three color temperature adjustment

6000K (±300K)

4000K (±300K)

3000K (±300K)

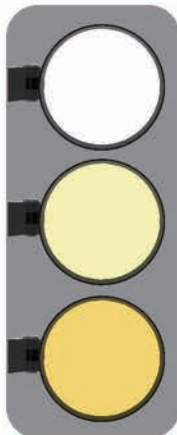

Portected by patent,if initated will be investigated
Design patent certificate number : 202030089800.1

Subject to the color in production at that time,if the colour of product above has been changed.

BL-1293



Multi-mode color temperature adjustment, Touch stepless dimming, With LED indicator light

BL-1293

Power: 10W LED (included)

Voltage: AC100-240V, DC12V

Colour Temp: 3000K-4000K-6000K

Lumen: 600 Max

CRI: ≥80a



Black

LED Instruction

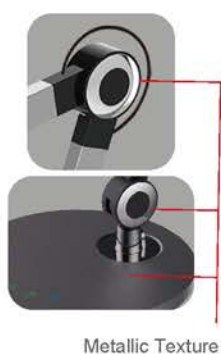

Sliver



Gold

Three color temperature adjustment

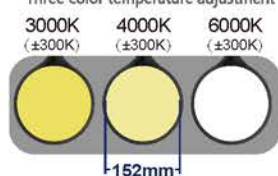

Portected by patent,if imitated will be investigated
Design patent certificate number : 202030090253.9

Subject to the color in production at that time,if the colour of product above has been changed.

Multi-mode color temperature adjustment, Touch stepless dimming

BL-1293-B

Power: 10W LED (included)

Voltage: AC100-240V, DC12V

Colour Temp: 3000K-4000K-6000K

Lumen: 600 Max

CRI: ≥80a

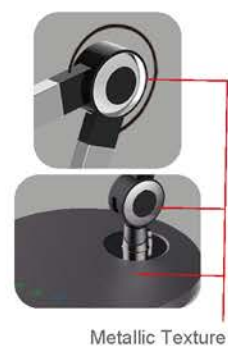

Black



White

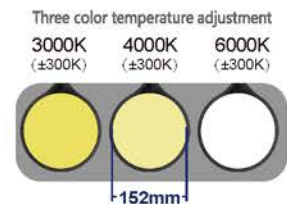

Subject to the color in production at that time, if the colour of product above has been changed.

Three color temperature adjustment, Mechanical Switch

BL-1293-E

Power: 10W LED (included)
Voltage: AC100-240V, DC12V

BL-1293-D



both desk lamp & clip lamp is available



Black Grey

Mechanical Switch Stepless Dimming



Three color temperature adjustment slightly touch

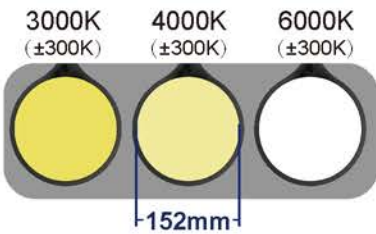

Champagne Gold



Silver White



Electro plating surface finishing

Subject to the color in production at that time,if the colour of product above has been changed.

BL-1295



Multi-mode color temperature adjustment, Touch stepless dimming,
With LED indicator light

BL-1295



Power: 10W LED (included)
Voltage: AC100-240V, DC12V
Colour Temp: 3000K-4000K-6000K
Lumen: 600 Max
CRI: ≥80a



Sliver

LED Instruction



Leisure mode



working mode



reading mode

brightness-

brightness+

Multi angle rotation

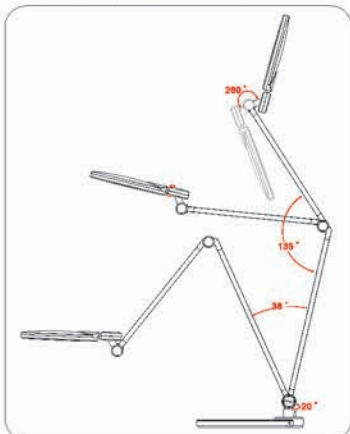

Three color temperature adjustment

3000K (±300K) 4000K (±300K) 6000K (±300K)

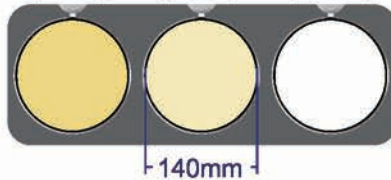

Black

Portected by patent,if initated will be investigated
Design patent certificate number : 202030449443.5

Subject to the color in production at that time,if
the colour of product above has been changed.

BL-1105



Multi-mode color temperature adjustment, Touch stepless dimming,
With LED indicator light

BL-1105

Power: 10W LED (included)
Voltage: AC100-240V, DC12V
Colour Temp: 3000K-4000K-6000K
Lumen: 600 Max
CRI: ≥80a



Silver



Black

Three color temperature adjustment

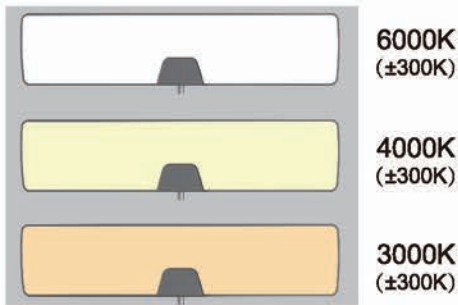

LED Instruction



Leisure mode working mode reading mode

brightness- brightness+

Multi angle rotation

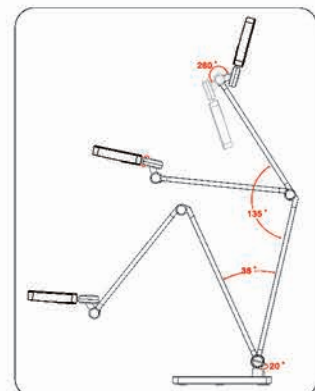

Portected by patent,if initated will be investigated
Design patent certificate number : 202030497994.9

Subject to the color in production at that time,if
the colour of product above has been changed.



BL-1063

Power: 8W LED (included)
Voltage: AC100-240V, DC13.5V
Colour Temp: 3000K-4000K-6500K
Lumen: 480 Max
CRI: $\geq 80a$



Three color temperature adjustment , Colorful atmosphere lamp , Rotating stepless dimming , With USB socket

BL-1063



Product Features

High grade silicone hose 360°rotating

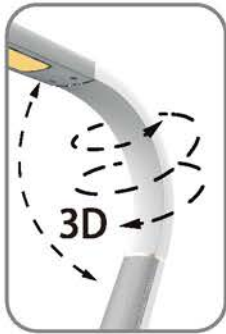

Colorful atmosphere lamp

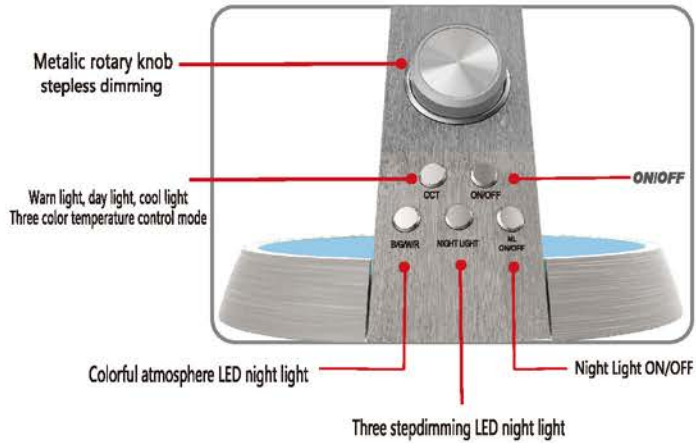

Black



Gold

Sliver



Portected by patent,if initated will be investigated
Design patent certificate number : 201830108046.4

Subject to the color in production at that time,if the colour of product above has been changed.



BL-1221

Power: 10W LED (included)
Voltage: AC100-240V, DC12V
Colour Temp: 3000K-4000K-6500K
Lumen: 600 Max
CRI: $\geq 80a$



Multi-mode color temperature adjustment , Touch stepless dimming , With LED indicator light

BL-1221

Power: 10W LED (included)
Voltage: AC100-240V, DC12V

Product Features



Black

LED Instruction

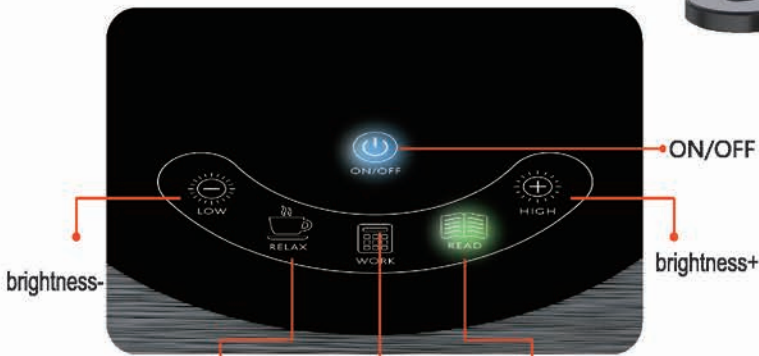

Leisure mode working mode reading mode



Multi angle rotation



Gold



White

- Touch light modulation
- Color temperature light
- The unique optical effect
- Intelligent memory
- High brightness SMD LED
- Super wide input voltage
- Low voltage output

Portected by patent,if initated will be investigated
Design patent certificate number : 201830570305.5

Subject to the color in production at that time,if the colour of product above has been changed.

Three color temperature adjustment, Touch stepless dimming

BL-1225

Power: 10W LED (included)
Voltage: AC100-240V, DC12V

Product Features



New patented invention technology
Gradable sliding adjust the height of lamp-post



Black



Gold

Sliver

Three color temperature adjustment Annular light source design



Touch light modulation



Color temperature light



Intelligent memory



High brightness SMD LED



Super wide input voltage



Low voltage output

Portected by patent,if initated will be investigated
Design patent certificate number : 201930083373.3
201930083655.3

Subject to the color in production at that time,if the colour of product above has been changed.

Three color temperature adjustment, Touch stepless dimming, With night light

BL-1229

Power: 10W LED (included)
Voltage: AC100-240V, DC13.5V

Product Features



Black

LED night light



USB charging



The USB socket can be used for charging your phone, camera, pad and laptop.



Sliver



Gold



Portected by patent,if initiated will be investigated
Design patent certificate number: 201930118340.8

Subject to the color in production at that time,if the colour of product above has been changed.

Intelligent automatic dimming, Manual dimming, with night light

BL-1108

Power: 10W LED (included)
Voltage: AC100-240V, DC13.5V



White



Black



Gold



Automatic dimming mode
Manual mode set up
Dimmable night light mode:

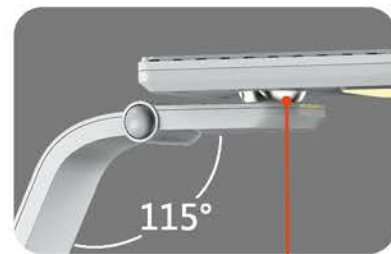

The spherical metallic joint can be flexibly rotated in many angles

Multi angle rotation

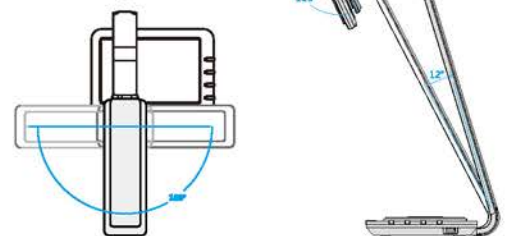

Subject to the color in production at that time, if the colour of product above has been changed.

Portected by patent, if initiated will be investigated
Design patent certificate number : 201721407877.8
201730322991.X

BL-1065

Three color temperature adjustment , Touch stepless dimming , With USB socket

Power: 8W LED (included)
Voltage: AC100-240V, DC13.5V

Product Features



LED indicator light



ON/OFF **Brightness Reducing** **Warm light, day light, cool light**
Three color temperature control mode **Brightness Increasing**



USB charging

5V/1A



The USB socket can be used for charging your phone, camera, pad and laptop.



Black



Sliver



Gold

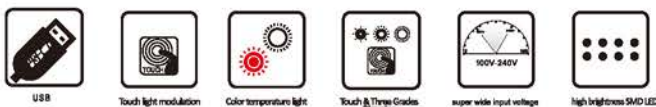

Portected by patent,if initiated will be investigated
Design patent certificate number : 201930118375.1

Subject to the color in production at that time,if the colour of product above has been changed.

Three color temperature adjustment , Touch stepless dimming

BL-1107

Power: 10W LED (included)
Voltage: AC100-240V, DC12V

Product Features



Three Color Temperature Adjusting Stepless Dimming



Multi angle rotation

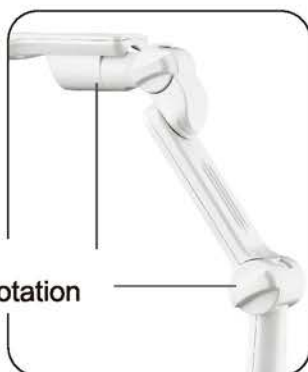

Touch light modulation



Color temperature light effects control mode



The unique optical effect arrangement



Intelligent memory stepless dimming



High brightness SMD LED



Super wide input voltage



Low voltage output



Clamp lamp function



Multi angle rotation

Protected by patent, if initiated will be investigated

Design patent certificate number: 201430078621.2
201420621542.6

Subject to the color in production at first time, if the colour of product above has been changed.

Three color temperature adjustment , Touch stepless dimming

BL-1207

Power: 10W LED (included)
Voltage: AC100-240V, DC12V

Product Features



Three Color Temperature
Adjusting Stepless Dimming



4000-4500K



6000-6500K



2800-3300K

Multi angle rotation

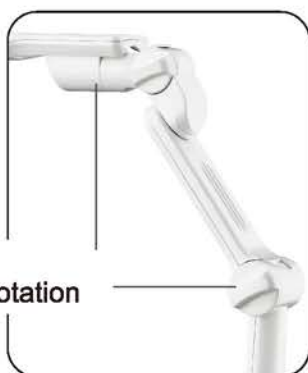

Black



Silver



White



Touch light modulation



Color temperature light effects control mode



The unique optical effect arrangement



High brightness SMD LED



Super wide input voltage



Low voltage output



Multi angle rotation

Protected by patent, if imitated will be investigated

Design patent certificate number : 201430078622.7

201430078715.X

201420621542.6

Subject to the color in production at that time, if the colour of product above has been changed.

Multi-Mode Color Temperture, Stepless Dimming

BL-1200

Power: 10W LED (included)
Voltage: AC100-240V, DC12V

Product Features

LED indicatorlight

Multi-Mode Color Temperature,
Stepless Dimming



metallic brushed
finished

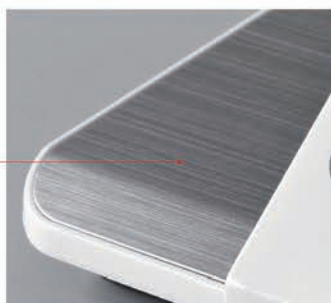

Black



Ruby Red



White



Touch light modulation



Using the light at night



Color temperature light effects control mode



Multi mode effect of light environment



Three grade touch dimmer



High brightness 3W/10 LED



Super wide input voltage



Low voltage output



Multi angle rotation

Protected by patent, if imitated will be investigated
Design patent certificate number: 201330114261.2

Subject to the color in production at that time, if the colour of product above has been changed.

BL-1201

Sensor Touch & Stepless Dimming

Power: 8W LED (included)
Voltage: AC100-240V, DC12V

Product Features



Sensor Touch & Stepless Dimming



Treasure Red



Sliver



White



Touch light modulation



Touch & Three Grades Dimming



Three grade touch dimmer



High brightness SMD LED



Super wide input voltage



Low voltage output



Multi angle rotation

Protected by patent, if initiated will be investigated
Design patent certificate number : 201230485491.5

Subject to the color in production at that time, if the colour of product above has been changed.

Sensor Touch & Stepless Dimming

BL-1203

Power: 10W LED (included)
Voltage: AC100-240V, DC12V

Product Features

Sensor Touch & Stepless Dimming



Multi-angle rotation Lampshape in lateral/Vertical

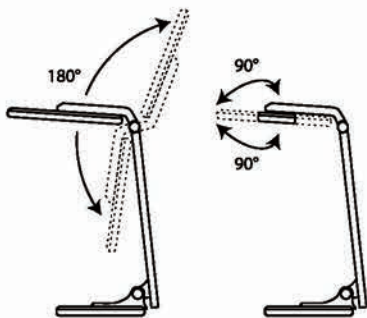

Folding function

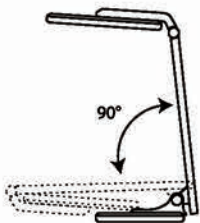

Sliver



White



Treasure Red

- Touch light modulation
- Touch & Three Grades Dimming
- Three grade touch dimmer
- Folding function
- High brightness SMD LED
- Super wide input voltage
- Low voltage output
- Multi angle rotation

Protected by patent, if imitated will be investigated
Design patent certificate number : 201630466996.5

Subject to the color in production at that time, if the colour of product above has been changed.

Three color temperature adjustment Stepless Dimming

BL-1206

Power: 10W LED (included)
Voltage: AC100-240V, DC12V

Product Features

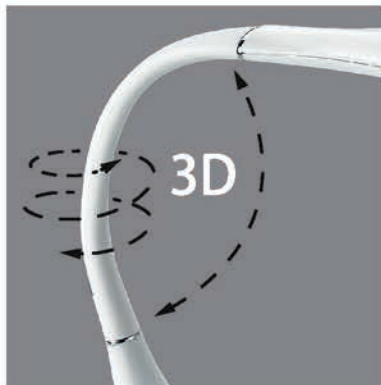

silicone hose design 360° rotating

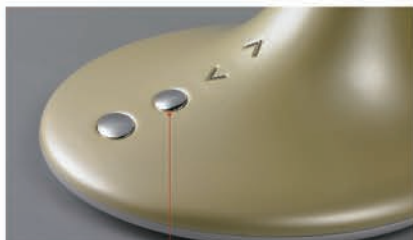

Three Color Temperature Stepless Dimming

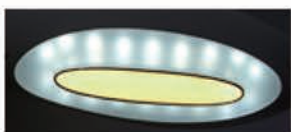

4000-4500K



6000-6500K

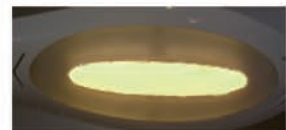

2800-3300K



White



Perry Blue



Perry Yellow



Touch light modulation



Color temperature light effects control mode



The unique optical effect arrangement



Intelligent memory stepless dimming



High brightness SMD LED



Super wide input voltage



Low voltage output



silicone hose design

Portected by patent,if initated will be investigating
Design patent certificate number : 201430078375.0

Subject to the color in production at that time,if the colour of product above has been changed.

BL-1855-C



Wireless charging , Three color temperature adjustment , Touch stepless dimming

BL-1855-C

Power: 8W LED (included)

Voltage: AC100-240V, DC13.5V

Colour Temp: 3000K-4000K-6000K

Lumen: 480 Max

CRI: $\geq 80a$



Mobile phone wireless charging function

Black

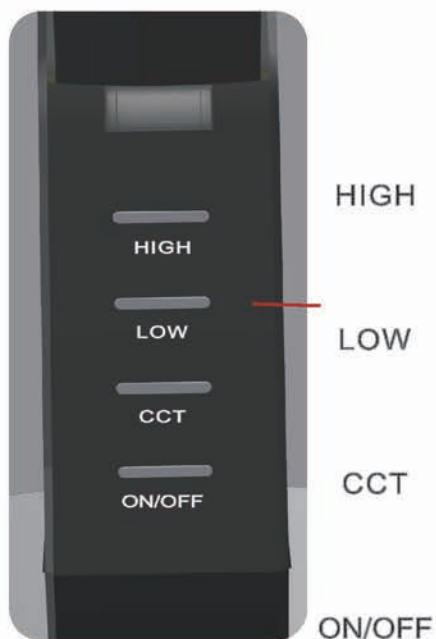

Three color temperature adjustment

6000K
($\pm 300K$)

4000K
($\pm 300K$)

3000K
($\pm 300K$)



White

Subject to the color in production at that time, if the colour of product above has been changed.

BL-1293-C



BL-1293-C

Wireless charging , Multi-mode color temperature adjustment ,
Touch stepless dimming , With LED indicator light

Power: 10W LED (included)
Voltage: AC100-240V, DC13.5V
Colour Temp: 3000K-4000K-6000K
Lumen: 600 Max
CRI: ≥80a



Mobile phone wireless charging function

Black



Gold



Sliver



Metallic Texture



Leisure mode working mode reading mode

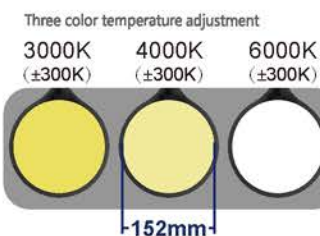

Subject to the color in production at that time, if the colour of product above has been changed.

BL-1295-C



Wireless charging , Multi-mode color temperature adjustment ,
Touch stepless dimming , With LED indicator light

BL-1295-C

Power: 10W LED (included)
Voltage: AC100-240V, DC13.5V
Colour Temp: 3000K-4000K-6000K
Lumen: 600 Max
CRI: ≥80a



Mobile phone wireless charging function



Black

LED Instruction



Leisure mode working mode reading mode

brightness- brightness+



Sliver

Multi angle rotation

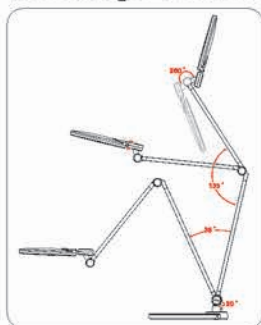

Three color temperature adjustment
3000K (±300K) 4000K (±300K) 6000K (±300K)



Subject to the color in production at that time, if the colour of product above has been changed.

BL-1105-C



Wireless charging , Multi-mode color temperature adjustment ,
Touch stepless dimming , With LED indicator light

BL-1105-C

Power: 10W LED (included)
Voltage: AC100-240V, DC13.5V
Colour Temp: 3000K-4000K-6000K
Lumen: 600 Max
CRI: ≥80a



Black

Mobile phone wireless charging function

Three color temperature adjustment

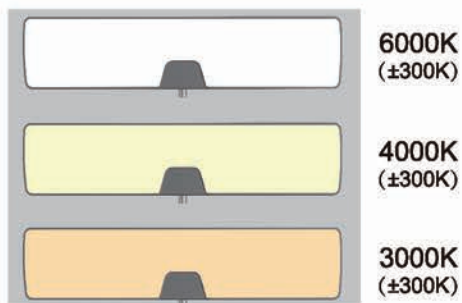

Silver

LED Instruction

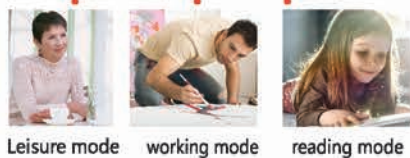

Leisure mode working mode reading mode

brightness- brightness+

Multi angle rotation

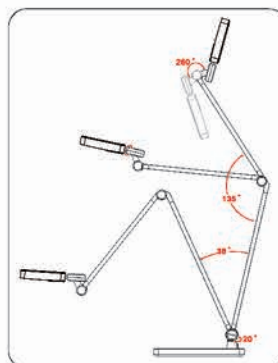

Subject to the color in production at that time, if the colour of product above has been changed.

Wireless charging , Multi-mode color temperature adjustment ,
Touch stepless dimming , With LED indicator light

BL-1223

Power: 10W LED (included)
Voltage: AC100-240V, DC13.5V

Mobile phone wireless
charging function

LED Instruction

ON/OFF

brightness+

brightness-

RELAX WORK READ LOW HIGH

Leisure mode working mode reading mode



Black



Multi angle rotation



Gold

White

Subject to the color in production at that time,if the colour of product above has been changed.

Wireless charging , Three color temperature adjustment , Touch stepless dimming , With night light

BL-1120

Power: 10W LED (included)
Voltage: AC100-240V, DC13.5V



White

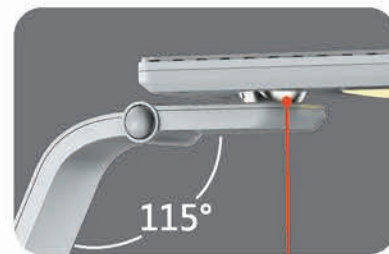

The spherical metallic joint can be flexibly rotated in many angles



Black



Gold

Multi angle rotation

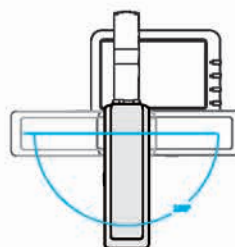

Subject to the color in production at that time, if the colour of product above has been changed.

Wireless charging , Three color temperature adjustment , Touch stepless dimming , LED indicator light

BL-1027-C

Power: 8W LED (included)
Voltage: AC100-240V, DC13.5V



Mobile phone wireless charging function



Brightness Increasing **Brightness Reducing** Warm light, day light, cool light
Three color temperature control mode **ON/OFF**

LED indicator light

- Press to turn on the lamp, the indicator light keeps bright after flashing 3 times.
- Press to turn off the lamp, the indicator light will be off after flashing 3 times.



Black

Three color temperature adjustment

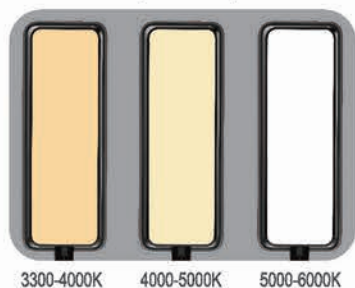

Gold

white

Subject to the color in production at that time, if the colour of product above has been changed.

Intelligent source 5V/13.5V , Three color temperature adjustment,
With night light , emergency lighting , Sliding stepless dimming

BL-1079

Power: 8W LED (included)
Voltage: AC100-240V, DC13.5V



TO ADJUST THE BRIGHTNESS OF THE LIGHT,
THE LIGHT WILL FOLLOW THE FINGER

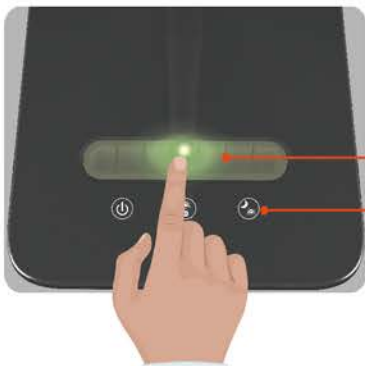

- Slide stepless dimming mode
- Three color temperature adjustment mode
- Two steps night light mode



White

The unique optical effect arrangement
(The new invention patent protection)

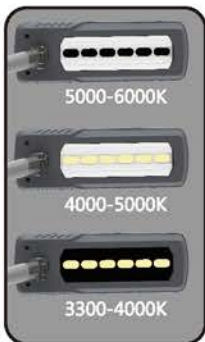

Blue



Black



Silver

Portected by patent,if imitated will be investigated
Design patent certificate number : 201730323237.8

Subject to the color in production at that time,if the colour of product above has been changed.

Subject to the color in production at that time,if the colour of product above has been changed.

BL-1283



HI-FI Bluetooth Speaker, Three color temperature adjustment,
Touch stepless dimming,

BL-1283



White

Power: 8W LED (included)
Voltage: AC100-240V, DC13.5V
Colour Temp: 3000K-4000K-6000K
Lumen: 480 Max
CRI: ≥80a



PREV Volume-	PAUSE	NEXT Volume+
DIM	CCT	ON/OFF



Black



Blue

HI-FI Speaker



Three color temperature adjustment

	6000K (±300K)
	4000K (±300K)
	3000K (±300K)

Portected by patent,if initated will be investigated
Design patent certificate number : 202030449445.4

Subject to the color in production at that time,if the colour of product above has been changed.

HI-FI BLUETOOTH SPEAKER MINI LED NIGHT LIGHT COLOR TEMPERATURE ADJUSTING
STEPLESS DIMMING USB CHARGING

BL-1231

Power: 10W LED (included)
Voltage: AC100-240V, DC13.5V

Product Features

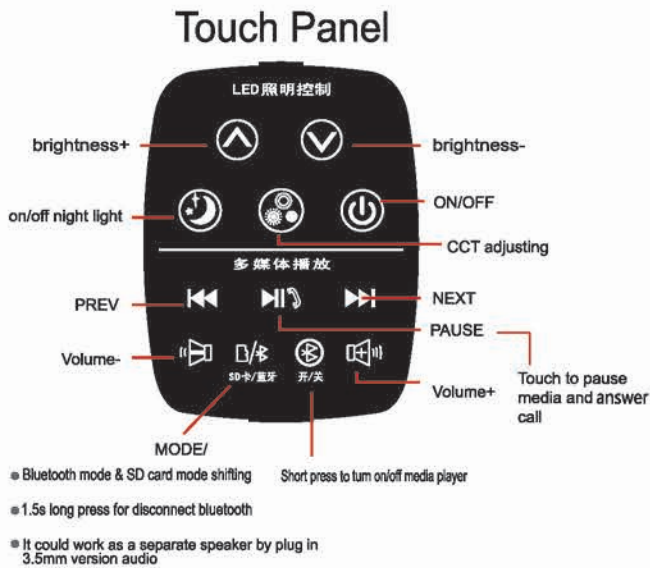

White



The unique optical effect arrangement
(The new invention patent protection)



Portected by patent,if initated will be investigated
Design patent certificate number : 201630278481.2



Rose Gold

Sliver

Black

Subject to the color in production at that time,if the colour of product above has been changed.

Alarm, Bird tweeter advanced wake up alarm, calendar & time display, three color temperature, Stepless dimming, with USB socket.

BL-1233

Power: 10W LED (included)
Voltage: AC100-240V, DC13.5V



Product Features

Digital display panel LCD



Bird ringtone wake-up alarm
Gradual wake up mode as dawn

Touch Panel

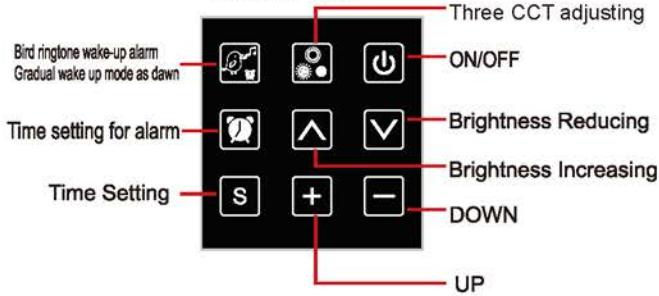

The unique optical effect arrangement
(The new invention patent protection)

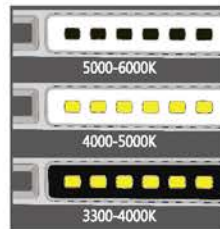

The USB socket can be used for charging your phone, camera, pad and laptop.

5V/700MA

Metal Joints



Black



white

Rose Gold

Portected by patent,if initated will be investigating

Design patent certificate number : 201630278474.2

Subject to the color in production at that time,if the colour of product above has been changed.

Gesture Sensor control , Color Temperature adjustment, Stepless Dimming Desk lamp

BL-1216

Power: 10W LED (included)
Voltage: AC100-240V, DC12V

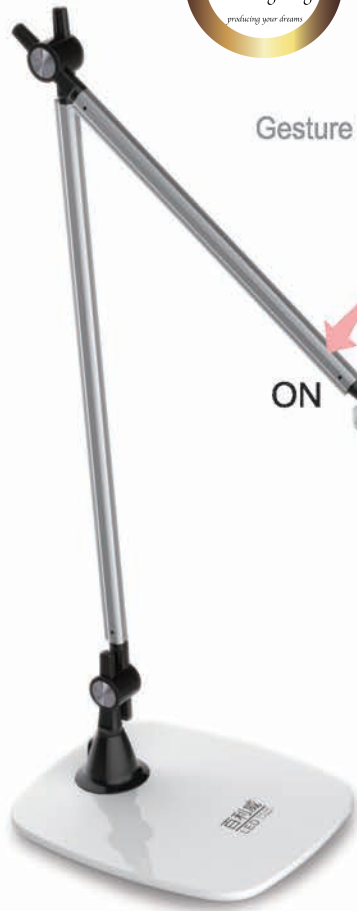

both desk lamp 8 clip lamp is available

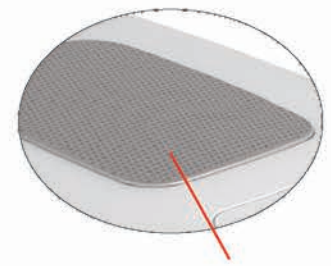
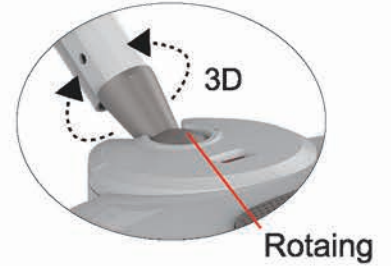

Stainless Steel for heat-dissipation

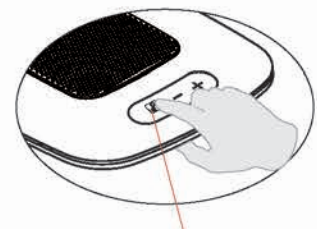

Three Colour temperature adjustment
Stepless dimming
Long pressing the key the light can be on/off



Black



Silver



White

The unique optical effect arrangement
(The new invention patent protection)

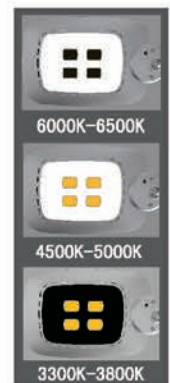

Subject to the color in production at that time, if the colour of product above has been changed.

Portected by patent, if initiated will be investigated
Design patent certificate number: 201530102841.9
201530310003.0

Gesture Sensor control , Color Temperature adjustment, Stepless Dimming Desk lamp

BL-1217

Power: 10W LED (included)
Voltage: AC100-240V, DC12V

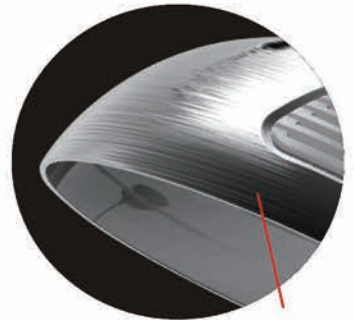

Metal wire drawing lampshade



Colour temperature adjustment Stepless dimming
Long pressing the key, the light can be on/off.



The unique optical effect arrangement
(The new invention patent protection)

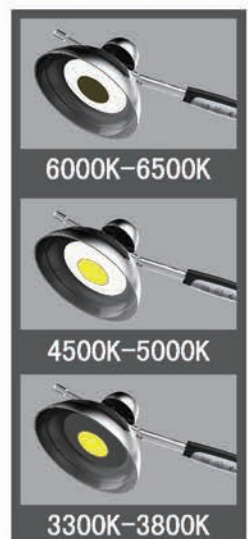

Portected by patent,if initated will be investigated
Design patent certificate number : 201530309846.9

Subject to the color in production at that time,if the colour of product above has been changed.

BL-1033



Multi-functional LED table lamp , Three color temperature adjustment , Double dimming mode

BL-1033



Power: 8W LED (included)
Voltage: AC100-240V, DC12V
Colour Temp: 3000K-4000K-6000K
Lumen: 480 Max
CRI: ≥80a



White



Black



Blue



Double Dimming Mode

- Slightly press to adjust brightness in three steps.
- Long press to stepless adjust brightness(10%-100%) .



Portected by patent,if initated will be investigated
Design patent certificate number : 202030090266.6

Subject to the color in production at that time,if the colour of product above has been changed.

BL-1281



Three color temperature adjustment, Touch stepless dimming,
With night light,

BL-1281



Power: 8W LED (included)

Voltage: AC100-240V, DC12V

Colour Temp: 3000K-4000K-6000K

Lumen: 480 Max

CRI: ≥80a



White



Insert pen

With night light



N-LIGHT



DIM



CCT



ON/OFF



Pink



Blue

Three color temperature adjustment



6000K
(±300K)



4000K
(±300K)



3000K
(±300K)

Subject to the color in production at that time, if the colour of product above has been changed.



BL-1285



Stepless adjustable color temperature, Rotating stepless dimming

BL-1285

Power: 8W LED (included)
Voltage: AC100-240V, DC12V



Stepless adjustable color temperature (3000K-6000K)

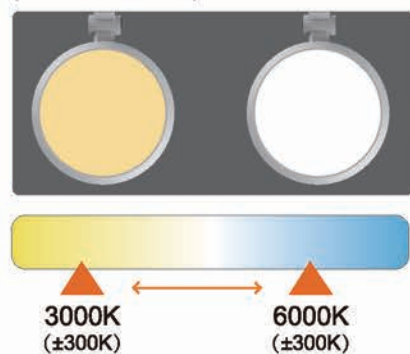

Portected by patent,if initated will be investigated
Design patent certificate number : 202030449437.X

Subject to the color in production at that time,if the colour of product above has been changed.

BL-1286

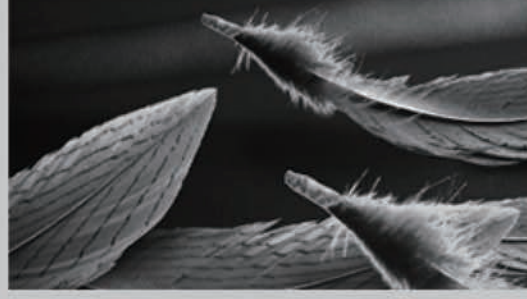

Stepless adjustable color temperature, Rotating stepless dimming

BL-1286



Power: 8W LED (included)

Voltage: AC100-240V, DC12V

Colour Temp: 3000K-4000K-6000K

Lumen: 500 Max

CRI: ≥80a



White

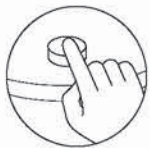

Slight Press: ON/OFF



Rotate: Dimming



Press & Rotate: CCT

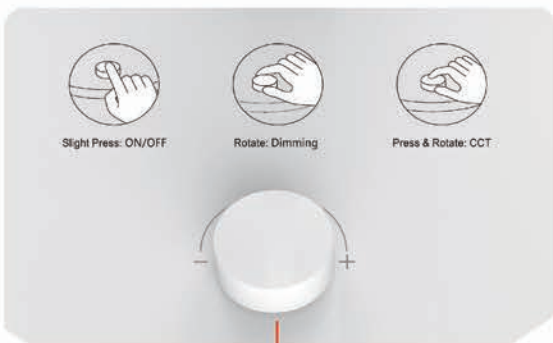

Mechanical Switch



Black



Silver

Stepless adjustable color temperature (3000K-6000K)



Protected by patent, if initiated will be investigated
Design patent certificate number: 202030449436.5

Subject to the color in production at that time, if the colour of product above has been changed.

BL-1287



Three color temperature adjustment, Touch stepless dimming
With LED indicator light

BL-1287



Fashion cool LED indicator

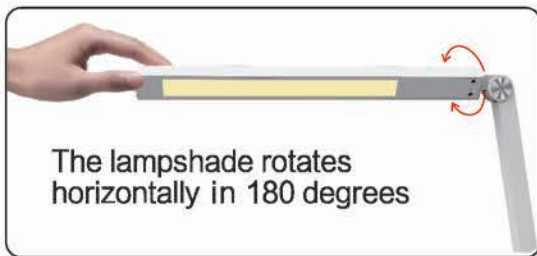
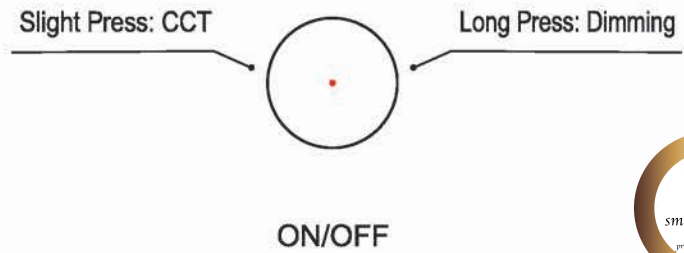

The lampshade rotates horizontally in 180 degrees

Three color temperature adjustment



Power: 8W LED (included)
 Voltage: AC100-240V, DC12V
 Colour Temp: 3000K-4000K-6000K
 Lumen: 450 Max
 CRI: ≥80a



Black



White

Protected by patent, if initiated will be investigated
 Design patent certificate number: 202030497998.7

Subject to the color in production at that time, if the colour of product above has been changed.

BL-1288



Three color temperature adjustment, Touch stepless dimming
With LED indicator light

BL-1288



Fashion cool LED indicator

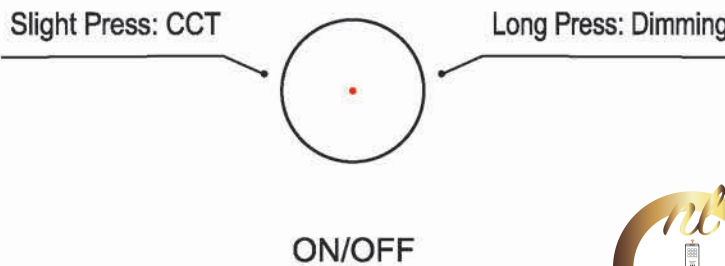

Black

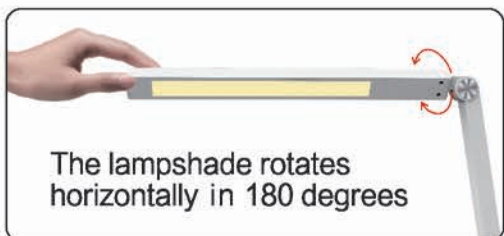

The lampshade rotates horizontally in 180 degrees

Three color temperature adjustment



Power: 8W LED (included)

Voltage: AC100-240V, DC12V

Colour Temp: 3000K-4000K-6000K

Lumen: 450 Max

CRI: ≥80a



White

Portected by patent,if initated will be investigating

Design patent certificate number : 202030497992.x

Subject to the color in production at that time,if the colour of product above has been changed.



Three color temperature adjustment, Touch stepless dimming,
With night light,

BL-1291



Power: 8W LED (included)
Voltage: AC100-240V, DC12V
Colour Temp: 3000K-4000K-6000K
Lumen: 480 Max
CRI: ≥80a



White



N-LIGHT



DIM



CCT



ON/OFF

Three color temperature adjustment

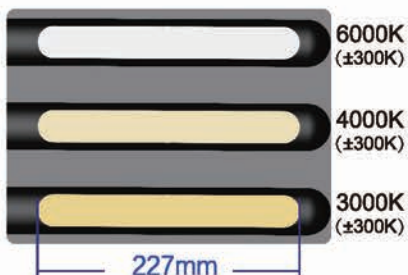

Black

Portected by patent,if initated will be investigated
Design patent certificate number : 202030449420.4

Subject to the color in production at that time,if
the colour of product above has been changed.



BL-1381



Three color temperature adjustment, Touch stepless dimming,
With night light,

BL-1381



Black

Power: 6W LED (included)
Voltage: AC100-240V, DC12V
Colour Temp: 3000K-4000K-6000K
Lumen: 380 Max
CRI: ≥80a



White



Blue

Three color temperature adjustment

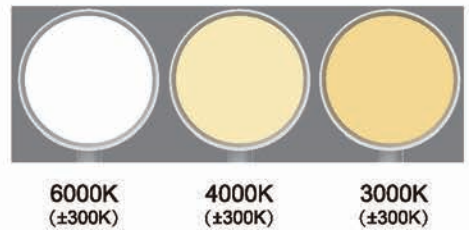

Portected by patent,if initated will be investigated
Design patent certificate number : 202030449425.7

Subject to the color in production at that time,if
the colour of product above has been changed.

Three color temperature adjustment, Three Steps Dimming, LED indicator light

BL-1023

Power: 8W LED (included)
Voltage: AC100-240V, DC12V

Product Features



- Touch the on/off key, all keys runs a round and LED indicator light flash 3 times, then on/off key keeps bright.
- Touch other function key, the key flash 3 times then turn off.
- Touch the key to turn off the lamp, the LED indicator light will be off after flashing 3 times.



Black



Sliver



Portected by patent, if initiated will be investigated

Design patent certificate number : 201930364882.3

Subject to the color in production at that time, if the colour of product above has been changed.

Three color temperature adjustment , Touch stepless dimming , LED indicator light

BL-1027

Power: 8W LED (included)
Voltage: AC100-240V, DC12V

Product Features



Three color temperature adjustment

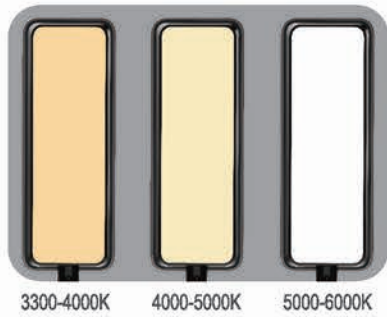

Black



Brightness Increasing **Brightness Reducing** Warn light, day light, cool light Three color temperature control mode **ON/OFF**

LED indicator light

- Press to turn on the lamp, the indicator light keeps bright after flashing 3 times.
- Press to turn off the lamp, the indicator light will be off after flashing 3 times.



Gold

white

Portected by patent,if imitated will be investigated
Design patent certificate number : 201930364887.6

Subject to the color in production at that time,if the colour of product above has been changed.

Three color temperature adjustment, Three Steps Dimming

BL-1066

Power: 8W LED (included)
Voltage: AC100-240V, DC12V

Product Features



- Three Steps Dimming
- Three color temperature adjustment slightly touch
- Main lamp on / off

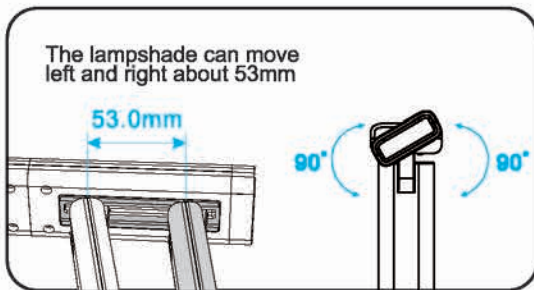

Three color temperature adjustment

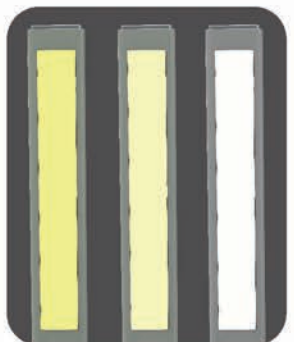

3300-4000K 4000-5000K 5000-6000K



Touch light modulation Color temperature light Touch & Three Grades Dimming warm white light voltage High brightness DVD LED Pen container



Pen Container

blue



white



Black

Portected by patent,if initiated will be investigated
Design patent certificate number : 201930147850.8

Subject to the color in production at that time,if the colour of product above has been changed.

Three color temperature adjustment , Touch stepless dimming , With LED indicator light

BL-1071

Power: 8W LED (included)
Voltage: AC100-240V, DC12V

Product Features

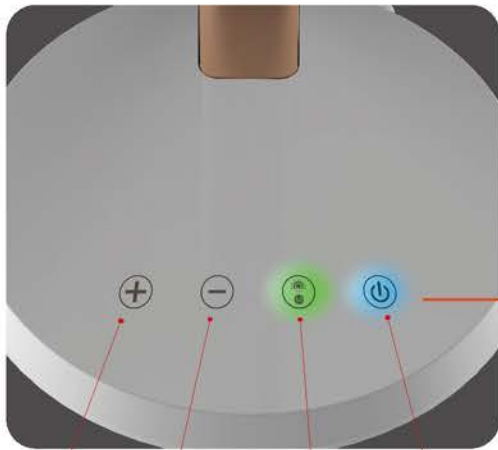

LED indicator light

Brightness Increasing **Brightness Reducing** Warm light, day light, cool light
Three color temperature control mode **ON/OFF**

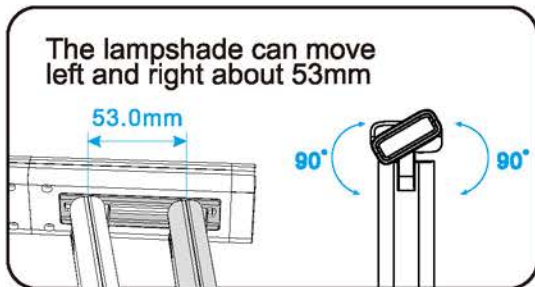

Black

Three color temperature adjustment

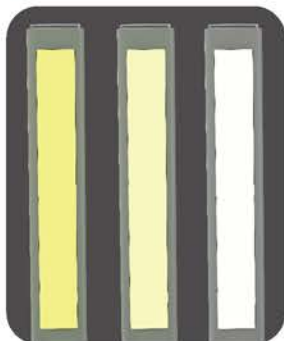

3300-4000K 4000-5000K 5000-6000K



blue



white



Mint Green



Portected by patent,if initiated will be investigated
Design patent certificate number : 201930147852.7

Subject to the color in production at that time,if the colour of product above has been changed.

BL-1072



Three color temperature adjustment , Sliding dimming , With LED indicator light

BL-1072



Power: 8W LED (included)

Voltage: AC100-240V, DC12V

Colour Temp: 3000K-4000K-6000K

Lumen: 480 Max

CRI: ≥80a



Sliding stepless dimming to adjust the brightness of the light



White

Slide stepless dimming mode:

- Touch on/off key,the initial brightness is 100% rate.Moving your finger on the translucent line up and down to stepless dimming smoothly, truly realize adjusting suitable brightness at will.
- Touch on/off key again to turn off the lamp and it memorize the current CCT and brightness.When turn on the lamp again,it remains last CCT & brightness, dimmer indicator light stop in the place as last time.



Three color temperature adjustment



Black



Grey

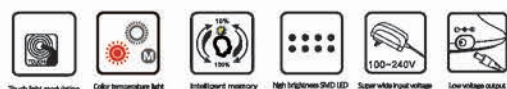

Portected by patent,if initated will be investigated
Design patent certificate number : 201830393459.1

Subject to the color in production at that time,if the colour of product above has been changed.

Three color temperature adjustment, Double dimming mode

BL-1871

Power: 6W LED (included)
Voltage: AC100-240V, DC12V

Product Features

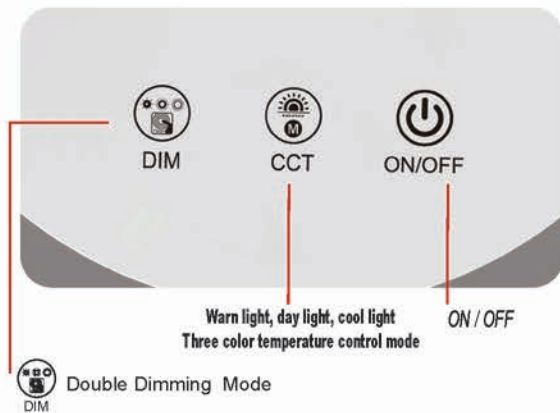

- Slightly press to adjust brightness in three steps.
- Long press to stepless adjust brightness(10%-100%) .

Three color temperature adjustment

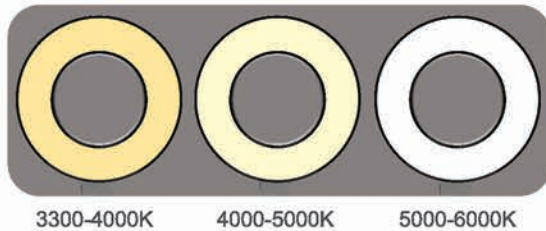

Portected by patent,if initiated will be investigated
Design patent certificate number : 201930364932.8

Subject to the color in production at that time,if the colour of product above has been changed.

Three color temperature adjustment, Double dimming mode

BL-1872

Power: 6W LED (included)
Voltage: AC100-240V, DC12V

Product Features

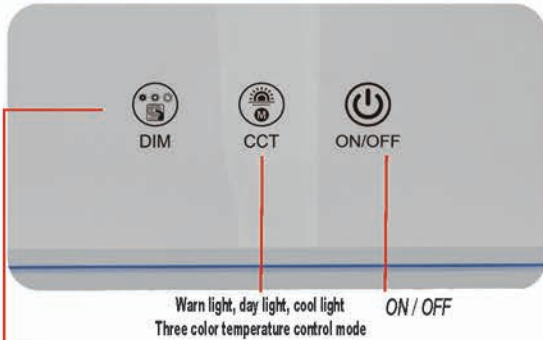

Double Dimming Mode
DIM

- Slightly press to adjust brightness in three steps.
- Long press to stepless adjust brightness(10%-100%) .

Three color temperature adjustment

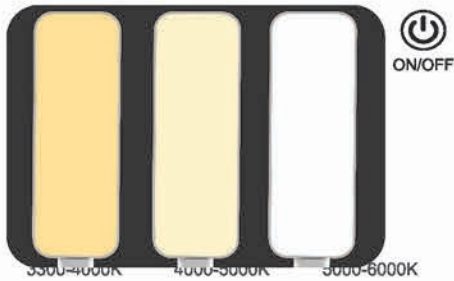

浅蓝
Blue



Black



Mint Green



White



Portected by patent,if initated will be investigated
Design patent certificate number : 201930364884.2

Subject to the color in production at that time,if the colour of product above has been changed.

Three color temperature adjustment, Double dimming mode

BL-1920

Power: 6W LED (included)
Voltage: AC100-240V, DC12V

Product Features

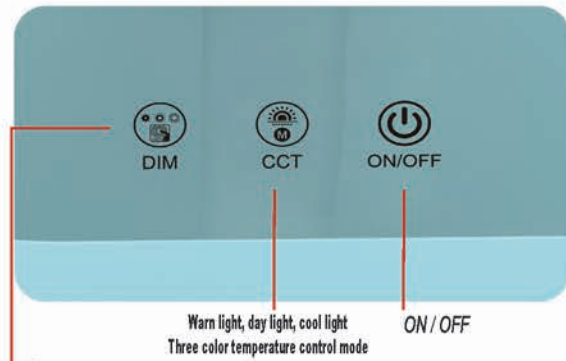

Double Dimming Mode

- Slightly press to adjust brightness in three steps.
- Long press to stepless adjust brightness(10%-100%) .

Three color temperature adjustment

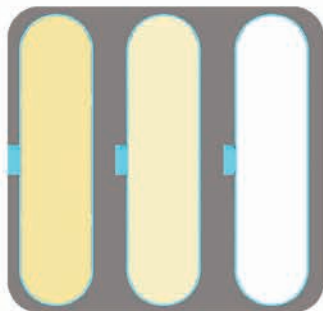

3300-4000K 4000-5000K 5000-6000K



Blue



Black



Mint Green



White



Portected by patent,if initiated will be investigated
Design patent certificate number : 201930364889.5

Subject to the color in production at that time,if the colour of product above has been changed.

Three color temperature adjustment, Double dimming mode

BL-1921

Power: 6W LED (included)
Voltage: AC100-240V, DC12V

Product Features



Three color temperature adjustment

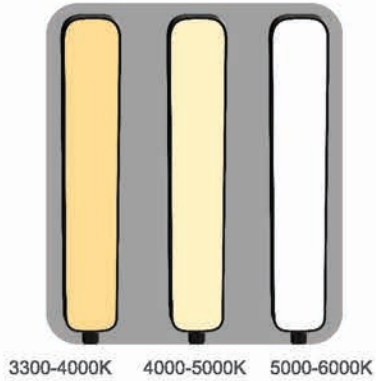

Double Dimming Mode
DIM

- Slightly press to adjust brightness in three steps.
- Long press to stepless adjust brightness(10%-100%) .



Black



White



Blue



Portected by patent,if initated will be investigated
Design patent certificate number : 201930364924.3

Subject to the color in production at that time,if the colour of product above has been changed.

Three color temperature adjustment, Mechanical Switch

BL-1872-S

Power: 6W LED (included)
AC220V

Product Features

Three color temperature adjustment

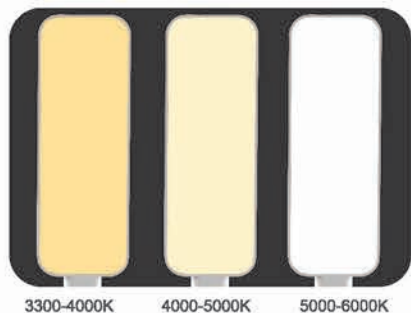

Warm light, day light, cool light
Three color temperature control mode ON/OFF



Blue



White



Mint Green



Black

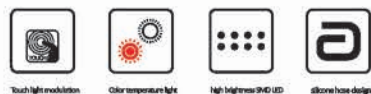

Subject to the color in production at that time, if the colour of product above has been changed.

Emergency charging function, Three color temperature adjustment,
Touch stepless dimming

BL-1921-C

Power: 4W LED (included)
DC5V

Product Features

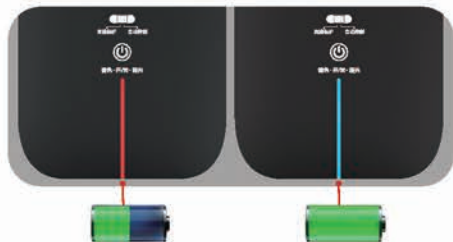

Charging, red indicator Full charge, Green indicator



Offline protection :

When the power is connected, the luminaire can't be used, only battery enter charging status, until it's fully charged.
When the power is disconnected, the luminaire neither be used nor be charged, only can be used until selected auto control mode. If the luminaire is not used for a long time, pull the switch to the offline protection mode to protect the battery from consuming capacity.

Auto control :

When the power is connected, the battery will enter the charging state while the desk lamp is being used.
When the power is disconnected, no matter the desk lamp is used or not, the battery will stand by and the desk lamp can be used at any time, but this mode will gradually consume the battery power.



Rechargeable desk lamp

Black



With one USB to DC3.5 leadwire



White



Blue

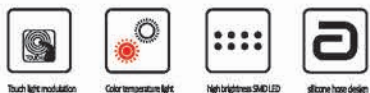

Touch light modulation Color temperature light High brightness SMD LED silicone base design

Subject to the color in production at that time, if the colour of product above has been changed.

Three color temperature adjustment, Three Steps Dimming

BL-1851

Power: 6W LED (included)
Voltage: AC100-240V, DC12V

Product Features

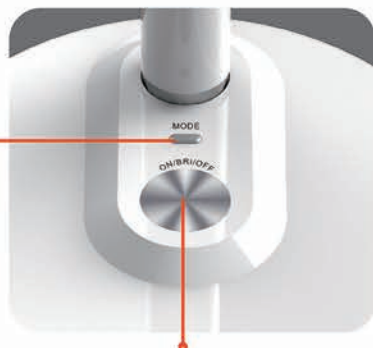

- Press to turn on the main lamp ,press again the lamp to adjust the brightness in high /middle/low.
- long press 1 second to turn off the lamp,turn on the lamp again can restore the last brightness rate
- The first time to touch it,the lamp will be all bright, the color temperature is day light,it can press the key to adjust the three step brightness.
- The second time to touch it, it comes with cool light , can press the key to adjust white light in the three step brightness.
- The third time to touch it,it comes with warm light, can press the key to adjust yellow light in the three step brightness.



Black



Three color temperature adjustment



White



Grey



Blue



Portected by patent,if initiated will be investigated

Design patent certificate number : 201830393324.5

Subject to the color in production at that time,if the colour of product above has been changed.

Three color temperature adjustment , Touch stepless dimming , With LED indicator light

BL-1853

Power: 6W LED (included)
Voltage: AC100-240V, DC12V

Product Features



short press to turn on the lamp and long press 1 second to turn off the light, turn on the lamp again can restore the brightness rate

- First time to touch it, the lamp will be in nature light and all bright. Press +/- to adjust the brightness.
- Second time to touch it, it becomes cool light and all bright. Press +/- to adjust the brightness.
- Third time to touch it, it becomes warm light and all bright. Press +/- to adjust the brightness.



Blue



Three color temperature adjustment

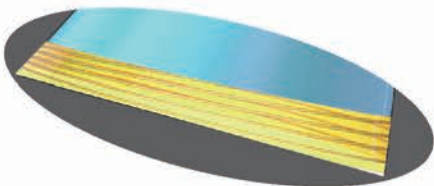

Black



White



Grey



Touch light modulation



Color temperature light



Touch & Three Grades Dimming



super wide input voltage



High brightness SMD LED

Portected by patent, if imitated will be investigated

Design patent certificate number : 201830393381.3

Subject to the color in production at that time, if the colour of product above has been changed.

wood grain,color temperature adjustment,stepless dimming

BL-1081

Power: 8W LED (included)
Voltage: AC100-240V, DC12V

Product Features

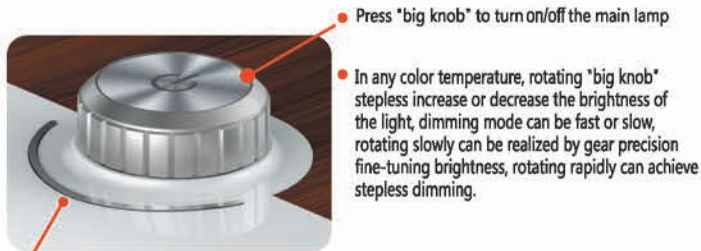

- Press "big knob" to turn on/off the main lamp
- In any color temperature, rotating "big knob" stepless increase or decrease the brightness of the light, dimming mode can be fast or slow, rotating slowly can be realized by gear precision fine-tuning brightness, rotating rapidly can achieve stepless dimming.

- The first time to touch it, the lamp will be all bright, can rotate "big knob" stepless increase or decrease the brightness of the light.
- The second time to touch it, the white light becomes brighter, can rotate "big knob" stepless increase or decrease the brightness of the light.
- The third time to touch it, the warm light becomes brighter, can rotate "big knob" stepless increase or decrease the brightness of the light.



Clear and natural water transfer printing wood grain design, exhale the natural atmosphere of the original ecology, give you a quiet and leisurely reading atmosphere

The unique optical effect arrangement
(The new invention patent protection)

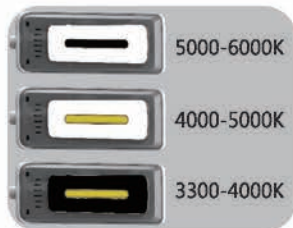

Cherrywood grain



Beechwood grain



Rosewood grain

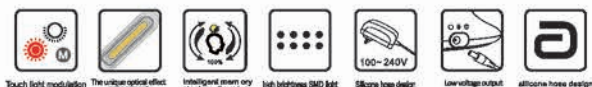

Portected by patent,if initated will be investigated
Design patent certificate number : 201730322992.4

Subject to the color in production at that time,if the colour of product above has been changed.

Three color temperature adjustment, Stepless dimming

BL-1325

Power: 6W LED (included)
Voltage: AC100-240V, DC12V

Product Features



5000-6000K

4000-5000K

3300-4000K



Brightness Increasing

Brightness Reducing

Warm light, day light, cool light
Three color temperature control mode

ON/OFF



MT-932

Mechanical Switch



White



Grey

Blue

Green

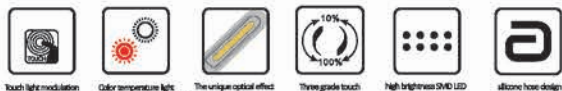

Portected by patent,if initated will be investigated
Design patent certificate number : 201630092402.9

Subject to the color in production at that time,if the colour of product above has been changed.

Three color temperature adjustment, Stepless dimming

BL-1327

Power: 6W LED (included)
Voltage: AC100-240V, DC12V

Product Features

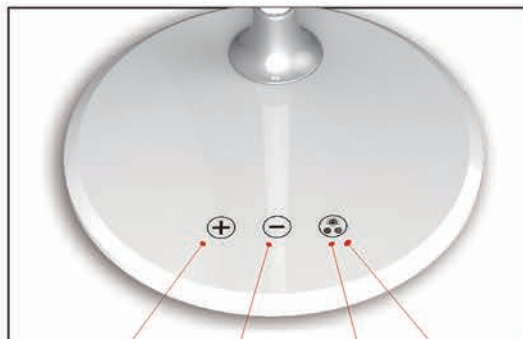

Brightness Increasing **Brightness Reducing** **Color temperature mode** **ON/OFF**



The unique optical effect arrangement
(The new invention patent protection)



3300-4000K

4000-5000K

5000-6000K



Blue



Black



Sliver



Green

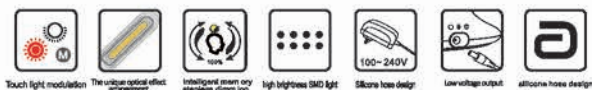

Subject to the color in production at that time, if the colour of product above has been changed.

Three color temperature adjustment, Stepless dimming

BL-1328

Power: 6W LED (included)
Voltage: AC100-240V, DC12V

Product Features



LED indicator light
ON/OFF

Brightness Increasing **Brightness Reducing** **Color temperature mode**



Gold

The unique optical effect arrangement
(The new invention patent protection)

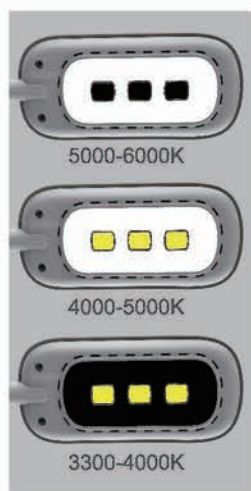

Silver



Grey



Rose Gold



Touch light control Light effect Color temperature control The unique optical effect arrangement Three grade touch dimming High brightness LED Slim design

Protected by patent, if imitated will be investigated
Design patent certificate number: 201630278485.0

Subject to the color in production at that time, if the colour of product above has been changed.

Three Steps Dimming With Night Light

BL-1391

Power: 6W LED (included)
Voltage: AC100-240V, DC12V

Product Features



Three Steps Dimming



White



Black



Sliver

- Touch light modulation
- Using the light at night
- Touch & Three Grades Dimming
- Multi mode effect of light environment
- High brightness SMD LED
- Super wide input voltage 100-240V
- Low voltage output
- Silicone hose design

Portected by patent,if initated will be investigated
Design patent certificate number : 201330114072.5

Subject to the color in production at that time,if the colour of product above has been changed.

Three steps dimming

BL-1392

Power: 6W LED (included)
Voltage: AC100-240V, DC12V



Product Features

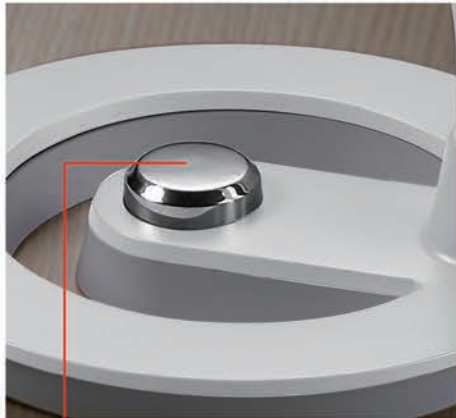

Three Steps Dimming



Treasure Red



Sliver



White



黑色
Black



Touch light modulation



Touch & Three Grades Dimming



high brightness SMD LED



Super wide input voltage



Low voltage output



silicone hose design

Portected by patent,if imitated will be investigated
Design patent certificate number : 201330489702.7

Subject to the color in production at that time,if the colour of product above has been changed.

With Magnifier, Three steps dimming

BL-1208A

Power: 5W LED (included)
Voltage: AC100-240V, DC12V

Product Features



Magnifier



Three Steps Dimming



Black



Treasure Red



White

- 
Touch light modulation
- 
Touch & Three Grades Dimming
- 
Magnifier device
- 
High brightness 5W LED
- 
Super wide input voltage
- 
Low voltage output
- 
Aftershow home design

Portected by patent,if initiated will be investigated
Design patent certificate number : 201430338037.6

Subject to the color in production at that time,if the colour of product above has been changed.

With Magnifer, Three steps dimming

BL-1205

Power: 5W LED (included)
Voltage: AC100-240V, DC12V

Product Features



Magnifier



Three Grades Dimming



Red



White



Silver

BL-1856

Mechanical Switch



Mechanical Switch



Silver



Treasure Red



White



Touch light modulation



Touch & Three Grades Dimming



Magnifier device



High brightness SMD LED



Super wide input voltage



Low voltage output



silicone hose design

Portected by patent,if imitated will be investigated
Design patent certificate number : 201430339660.3

Subject to the color in production at that time,if the colour of product above has been changed.

BL-1618



Three color temperature adjustment, Touch stepless dimming, LED indicator light

BL-1618



LED indicator light

- Turn on the lamp, the eyes indicator light keeps bright after flashing 3 times.

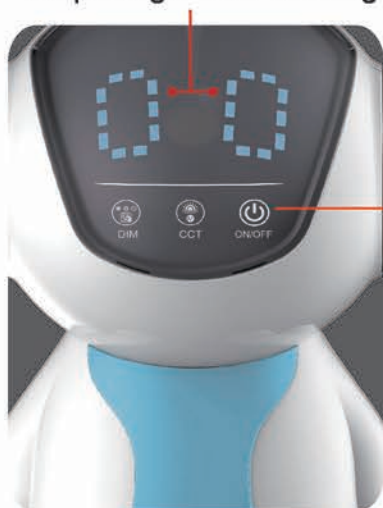

Blue

Three color temperature adjustment



6000K (±300K) 4000K (±300K) 3000K (±300K)

Power: 8W LED (included)
 Voltage: AC100-240V, DC12V
 Colour Temp: 3000K-4000K-6000K
 Lumen: 480 Max
 CRI: ≥80a



Pink



White

Portected by patent,if initated will be investigating
 Design patent certificate number : 201930649321.8

Subject to the color in production at that time,if the colour of product above has been changed.

LED night light , Three color temperature adjustment , Three Steps Dimming

BL-1601



Product Features

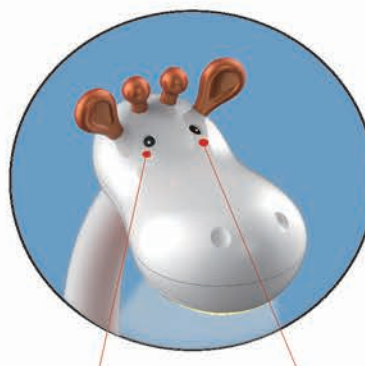

- Three Steps Dimming slightly touch
- Warm light, day light, cool light
Three color temperature control mode
- Long Press 1 second to turn on or turn off the LED night light
- Long press 1 second to turn on or turn off the main lamp

Silicone hose

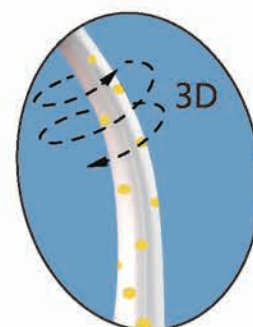

AC: 100~240V
 DC: 12V
 POWER: 6W
 QTY: 6 PCS/CTN

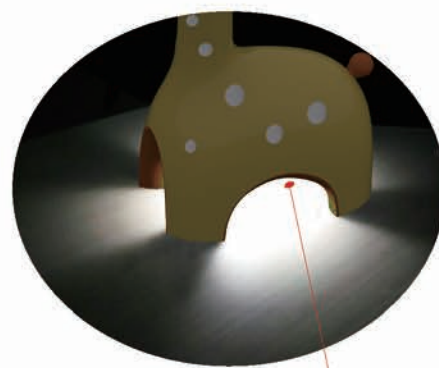

LED night light



LED night light



Touch light modulation



Color temperature light



Touch & Three Grades Dimming



super wide input voltage



High brightness SMD LED



silicone hose design

Subject to the color in production at that time, if the colour of product above has been changed.

Portected by patent, if initiated will be investigated
Design patent certificate number : 201730025245. 4

LED night light , Three color temperature adjustment , Three Steps Dimming

BL-1603

Product Features



Lampshade can rotate 40 degrees



Lampshade can move left to right 18mm

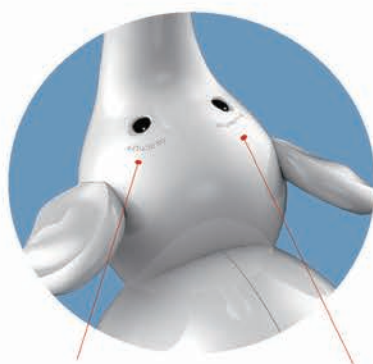

- Warm light, day light, cool light
Three color temperature control mode
- Three Steps Dimming slightly touch
- Long press 1 second to turn on or turn off the main lamp
- Long Press 1 second to turn on or turn off the LED night light

AC: 100~240V
 DC: 12V
 POWER: 6W
 QTY: 6 PCS/CTN

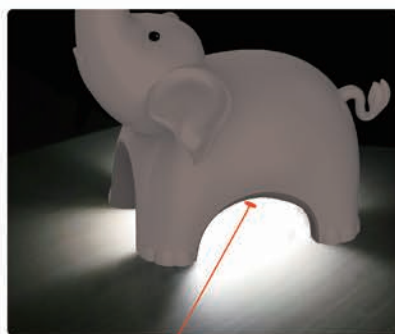

LED night light



white



blue



pink



LED night light



Touch light modulation



Color temperature light



Touch & Three Grades Dimming



super wide input voltage



High brightness SMD LED

Portected by patent,if initiated will be investigated
 Design patent certificate number : 201730025243. 5

Subject to the color in production at that time,if
 the colour of product above has been changed.

LED night light , Three color temperature adjustment , Three Steps Dimming

BL-1605



Product Features



- Three Steps Dimming slightly touch
- Warm light, day light, cool light
Three color temperature control mode
- Long Press 1 second to turn on or turn off the LED night light
- Long press 1 second to turn on or turn off the main lamp

AC: 100~240V
 DC: 12V
 POWER: 6W
 QTY: 6 PCS/CTN



blue



yellow



white

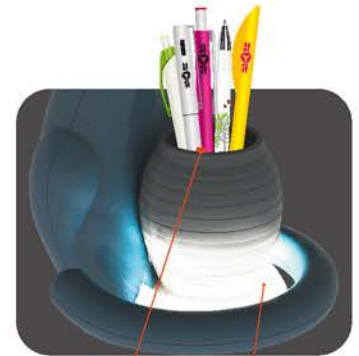

pen container LED night light



LED night light



Touch light modulation



Color temperature light



Touch & Three Grades Dimming



Pen container



super wide input voltage



Low voltage output



High brightness SMD LED

Subject to the color in production at that time, if the colour of product above has been changed.

Portected by patent, if imitated will be investigated
Design patent certificate number : 201730025234.6

LED night light , Three color temperature adjustment , Three Steps Dimming

BL-1606

Product Features



AC: 100~240V
DC: 12V
POWER: 6W
QTY: 6 PCS/CTN



- Three Steps Dimming slightly touch
- Warm light, day light, cool light
Three color temperature control mode
- Long Press 1 second to turn on or turn off the LED night light
- Long press 1 second to turn on or turn off the main lamp



pink



yellow



white

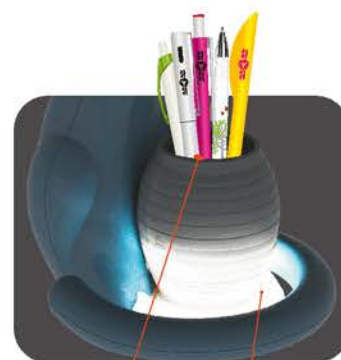

pen container LED night light



LED night light



Touch light modulation



Color temperature light



Touch & Three Grades Dimming



Pen container



100V-240V



Low voltage output



High brightness SMD LED

Subject to the color in production at that time, if the colour of product above has been changed.

Protected by patent, if initiated will be investigated
Design patent certificate number: 201730151657.2

LED night light , Three color temperature adjustment , Three Steps Dimming

BL-1607



AC: 100~240V
DC: 12V
POWER: 6W
QTY: 6 PCS/CTN

Product Features

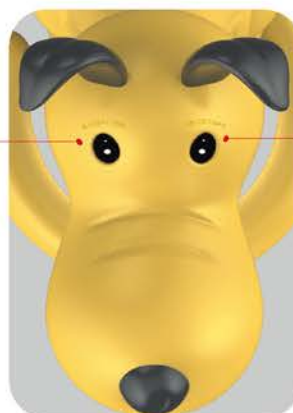

- Three Steps Dimming slightly touch
- Warm light, day light, cool light
Three color temperature control mode
- Long Press 1 second to turn on or turn off the LED night light
- Long press 1 second to turn on or turn off the main lamp

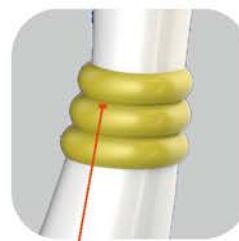

Plastic hose, easy to control, adjust the lamp angle



white



pink



yellow

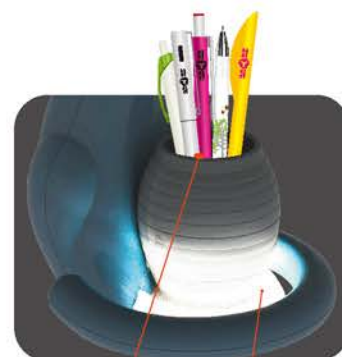

pen container LED night light



Subject to the color in production at that time, if the colour of product above has been changed.

Protected by patent, if initiated will be investigated
Design patent certificate number : 201730151658.7



Product Features



- Three Steps Dimming slightly touch
- Warm light, day light, cool light
Three color temperature control mode
- Long Press 1 second to turn on or turn off the LED night light
- Long press 1 second to turn on or turn off the main lamp

AC: 100~240V
 DC: 12V
 POWER: 6W
 QTY: 6 PCS/CTN

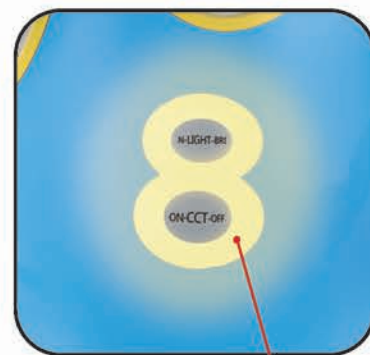

LED indicator light



blue



white



yellow



LED night light



Touch light modulation



Color temperature light



Touch & Three Grades Dimming



super wide input voltage



High brightness SMD LED

Portected by patent,if initiated will be investigated
 Design patent certificate number : 201830297800.3

Subject to the color in production at that time,if the colour of product above has been changed.



AC: 100~240V
DC: 12V
POWER: 6W
QTY: 6 PCS/CTN

Product Features

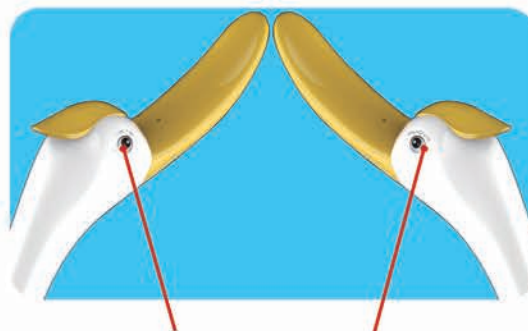

- Warm light, day light, cool light
Three color temperature control mode
- Three Steps Dimming slightly touch
- Long Press 1 second to turn on or turn off the main lamp
- Long Press 1 second to turn on or turn off the LED night light

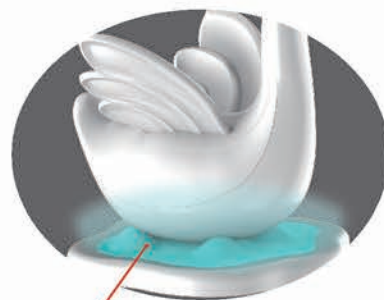

LED night light



white

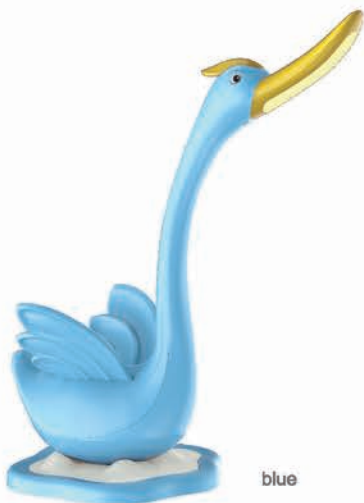

blue



Green



LED night light



Touch light modulation



Color temperature light



Touch & Three Grades Dimming



super wide input voltage



High brightness SMD LED



silicone hose design

Portected by patent,if initated will be investigated
Design patent certificate number: 201830393458.7

Subject to the color in production at that time,if the colour of product above has been changed.

Three color temperature adjustment, Touch stepless dimming

BL-1908



Product Features

Three color temperature adjustment

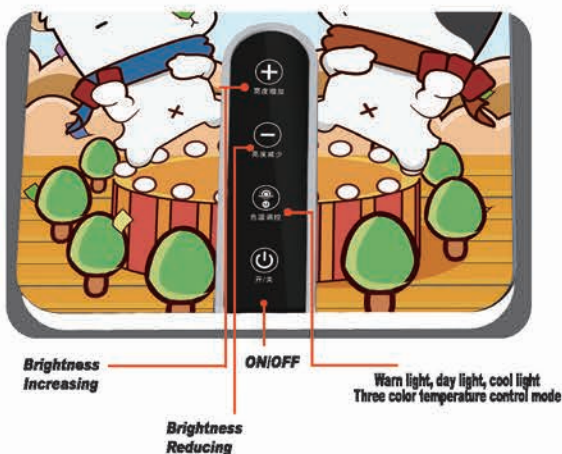
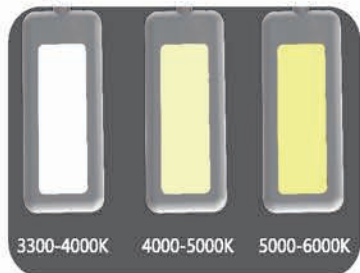

Yoyo Bear



Gaga duck



Hatchie

AC:100~240V
DC:12V
POWER:6W
Touch stepless dimming



Subject to the color in production at that time,if the colour of product above has been changed.

Three color temperature adjustment, Three Steps Dimming

BL-1128

Power: 4W LED (included)
Voltage: AC100-240V, DC12V

Product Features



Desk-Clip Multi-using Design



Three steps Dimming



BL-1028

Mechanical Switch



Mechanical Switch



- 
 按摺式开关
 Mechanical Switch
- 
 触摸调光
 touch-light adjustment
- 
 智能三步触摸调光
 touch & Three Steps Dimming
- 
 夹灯功能
 Clamp lamp function
- 
 大亮度 LED 光源
 High-brightness SMD LED
- 
 100-240V
 Super wide input voltage
- 
 DC 12V
 Low voltage output
- 
 硅胶软管设计
 silicone hose design

Portected by patent,if initiated will be investigated
Design patent certificate number :201330489704.6

Subject to the color in production at that time,if the colour of product above has been changed.

Three color temperature adjustment, Three Steps Dimming

BL-1238

Power: 5W LED (included)
Voltage: AC100-240V, DC12V

Product Features



Desk-Clip Multi-using Design



Three steps Dimming



L-Blue



Green



White

BL-1138

Mechanical Switch



Mechanical Switch



L-Blue



Green



White

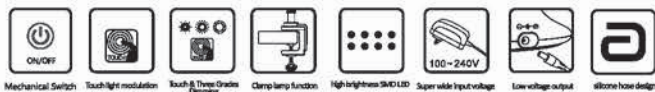

Portected by patent,if imitated will be investigated
Design patent certificate number : 201330489696.5

Subject to the color in production at that time,if the colour of product above has been changed.

BI-1903



Multi-functional LED Floor lamp
Double luminaire/ Three CCT/ Stepless dimming



BI-1903

Power: 15W LED (included)
Voltage: AC100-240V, DC12V
Colour Temp: 3000K-4000K-6000K



White

Black



Black Nickel

Portected by patent,if imitated will be investigated
Design patent certificate number : 202130178375.8

Subject to the color in production at that time,if the colour of product above has been changed.

Multi-functional LED Floor lamp

Double luminaire/ Three CCT/ Stepless dimming

BI-1903



Up lighting --- CCT & Dimming control for up lighting

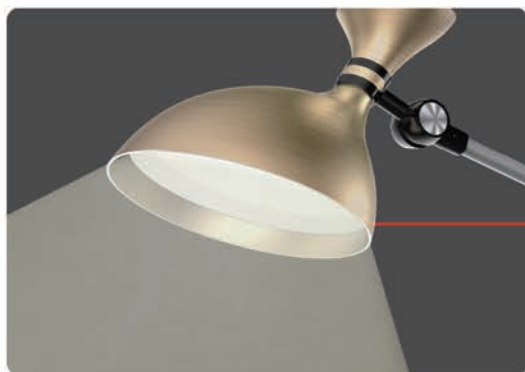
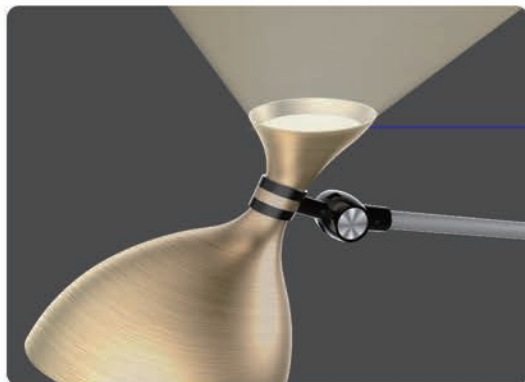

Up lighting ---

UP-CCT/DIM

UP-ON/OFF

Down lighting ---

DIM

CCT

ON / OFF

With LED indicator light

Down lighting --- CCT & Dimming control for down lighting

Three color temperature adjustment

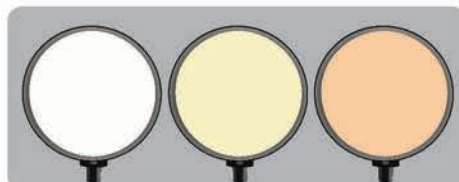

6000K
(±300K)

4000K
(±300K)

3000K
(±300K)

Metal Swivel



Precise & durable Metal Swivel

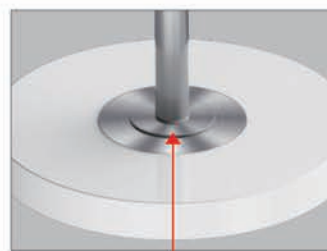

Decorative with brushed panel

BI-1903-P



Multi-functional LED Floor lamp

Multi-functional LED Floor lamp

Double luminaire/ Three CCT/ Stepless dimming/ Supporting tray



BI-1903-P

Power: 15W LED (included)

Voltage: AC100-240V, DC12V

Colour Temp: 3000K-4000K-6000K



White

Black

Black Nickel

Copper

Subject to the color in production at that time, if the colour of product above has been changed.

Multi-functional LED Floor lamp

Double luminaire/ Three CCT/ Stepless dimming/ Supporting tray

BI-1903-P



Up lighting --- CCT & Dimming control for up lighting

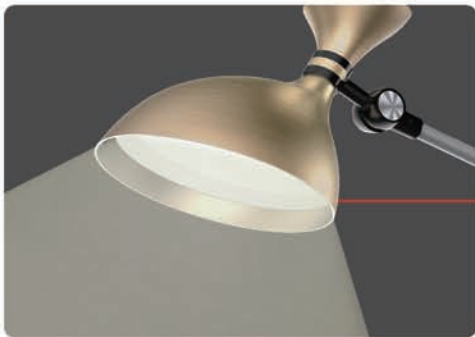
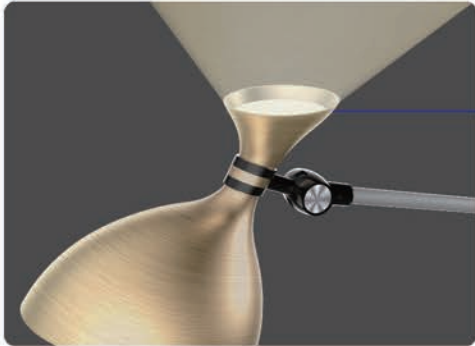

Up lighting ---

UP-CCT/DIM

UP-ON/OFF

Down lighting ---

DIM

CCT

ON / OFF

With LED indicator light

Down lighting --- CCT & Dimming control for down lighting

Metal Swivel



Precise & durable Metal Swivel

With supporting tray



Three color temperature adjustment

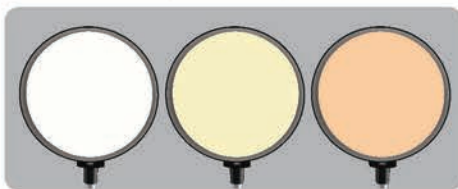

6000K
(±300K)

4000K
(±300K)

3000K
(±300K)

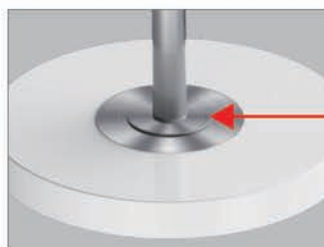

Decorative with brushed panel

BI-1903-U



Multi-functional LED Floor lamp

Double luminaire/ Three CCT/ Stepless dimming/ Supporting tray/ USB charging



BI-1903-U

Power: 15W LED (included)

Voltage: AC100-240V, DC13.5V

Colour Temp: 3000K-4000K-6000K



Double USB charging interface



White

Black



Copper

Black Nickel

Subject to the color in production at that time, if the colour of product above has been changed.

Multi-functional LED Floor lamp

Double luminaire/ Three CCT/ Stepless dimming/ Supporting tray/ USB charging

BI-1903-U



Up lighting --- CCT & Dimming control for up lighting

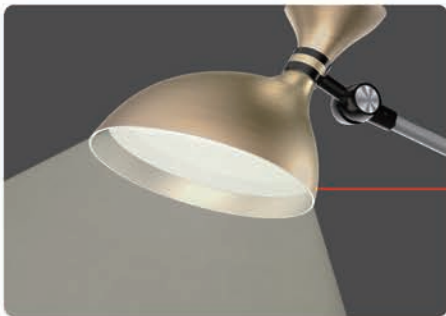
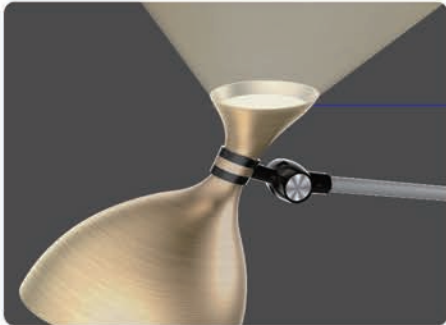

Up lighting ---

UP-CCT/DIM

UP-ON/OFF

Down lighting ---

DIM

CCT

ON / OFF

With LED indicator light

Down lighting --- CCT & Dimming control for down lighting

Metal Swivel



Precise & durable Metal Swivel

Double USB charging interface



Three color temperature adjustment



6000K
(±300K)

4000K
(±300K)

3000K
(±300K)

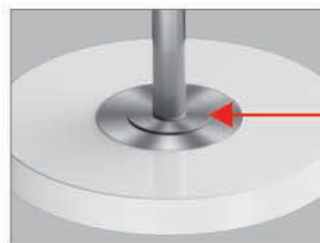

Decorative with brushed panel

BI-1903-C



Multi-functional LED Floor lamp

Multi-functional LED Floor lamp Double luminaire/ Three CCT/
Stepless dimming/ Supporting tray / Wireless charging



BI-1903-C

Power: 15W LED (included)
Voltage: AC100-240V, DC13.5V
Colour Temp: 3000K-4000K-6000K



Supporting tray with wireless charging



White

Black



Black Nickel

Copper

Portected by patent,if initated will be investingated
Design patent certificate number : 202130596880.4
202130597240.5

Subject to the color in production at that time,if the colour of product above has been changed.

Multi-functional LED Floor lamp Double luminaire/ Three CCT/
Stepless dimming/ Supporting tray / Wireless charging

BI-1903-C



Up lighting --- CCT & Dimming control for up lighting

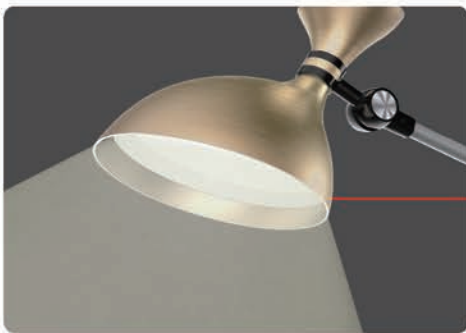
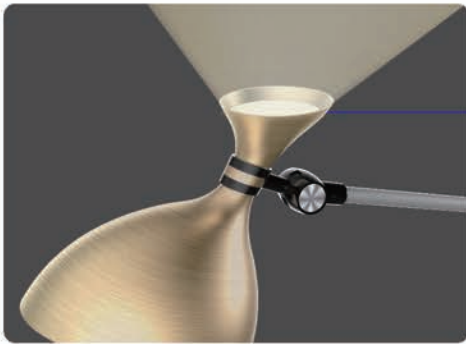

Up lighting ---

UP-CCT/DIM

UP-ON/OFF

Down lighting ---

DIM

CCT

ON / OFF

With LED indicator light

Down lighting --- CCT & Dimming control for down lighting

Metal Swivel



Precise & durable Metal Swivel

Supporting tray with wireless charging



Three color temperature adjustment



6000K
(±300K)

4000K
(±300K)

3000K
(±300K)



Decorative with brushed panel



BI-1913 Multi-functional LED Floor lamp



BI-1913

- Three CCT
- Stepless dimming

COLOR:
Silver, Grey, Champagne Gold



BI-1913-P

- LCD Display of time, calendar, temperature
- Supporting tray
- Three CCT
- Stepless dimming

COLOR:
Silver, Grey, Champagne Gold



BI-1913-U

- LCD Display of time, calendar, temperature
- Supporting tray
- USB charging
- Three CCT
- Stepless dimming

COLOR:
Silver, Grey, Champagne Gold



BI-1913-T

- LCD Display of time, calendar, temperature
- Three CCT
- Stepless dimming

COLOR:
Silver, Grey, Champagne Gold



BI-1913-C

- LCD Display of time, calendar, temperature
- Supporting tray
- Wireless charging
- Three CCT
- Stepless dimming

COLOR:
Silver, Grey, Champagne Gold



BI-1913



Multi-functional LED Floor lamp

Multi-functional LED Floor lamp Three CCT/ Stepless dimming



BI-1913

Power: 12W LED (included)
Voltage: AC100-240V, DC12V
Colour Temp: 3000K-4000K-6000K



Gold



Sliver

Portected by patent,if imitated will be investingated
Design patent certificate number : 202130178491.X

Multi-functional LED Floor lamp Three CCT/ Stepless dimming

BI-1913



Slant lampshade-large emitting area



Three color temperature adjustment

6000K
(±300K)

4000K
(±300K)

3000K
(±300K)

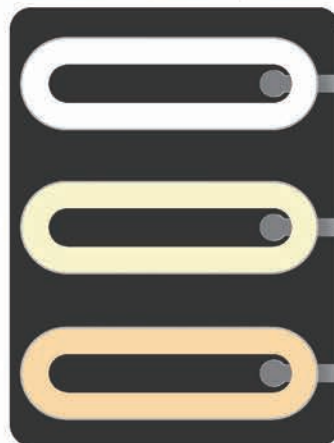

Metal Swivel



Precise & durable Metal Swivel

Brushed aluminum lamppost



brightness+



brightness-



CCT



ON/OFF

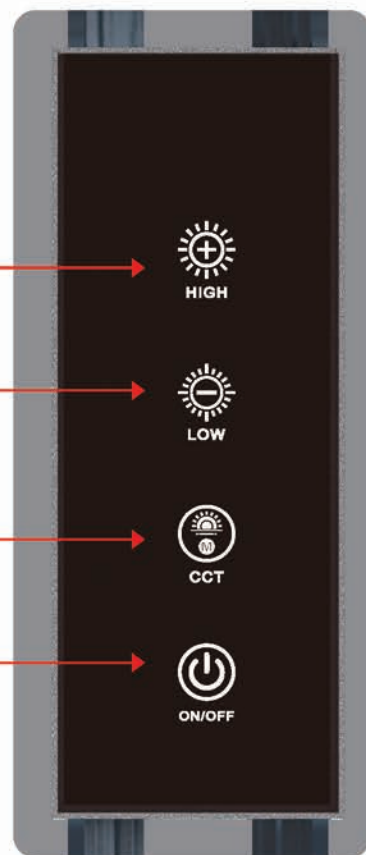

Decorative with brushed panel

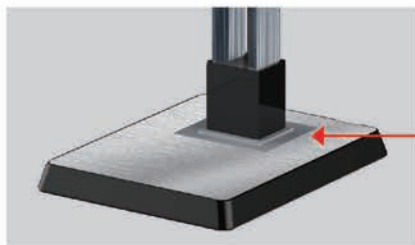

Subject to the color in production at that time, if the colour of product above has been changed.

BI-1913-P



Multi-functional LED Floor lamp LCD Display of time, calendar and temperature/ Three CCT/ Stepless dimming/ Supporting tray



BI-1913-P

Power: 12W LED (included)
Voltage: AC100-240V, DC13.5V
Colour Temp: 3000K-4000K-6000K



Gold



With supporting tray

Sliver

Multi-functional LED Floor lamp LCD Display of time, calendar and temperature/ Three CCT/ Stepless dimming/ Supporting tray

BI-1913-P

Slant lampshade-large emitting area



三色温调节
Three color temperature adjustment

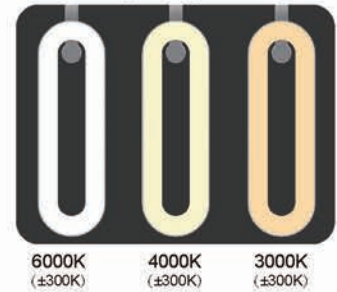

Metal Swivel

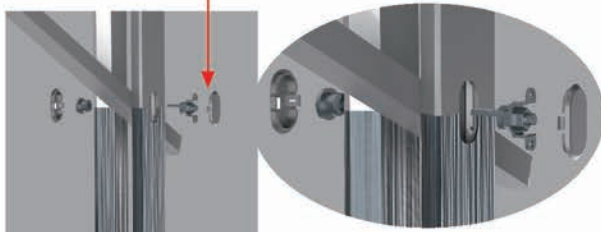

Precise & durable Metal Swivel

With supporting tray



Brushed aluminum lamp post



(First step: Long press ON/OFF to switch Red/Blue indicator light)
•Blue indicator light on, control LCD display function
•Red indicator light on, control main lamp

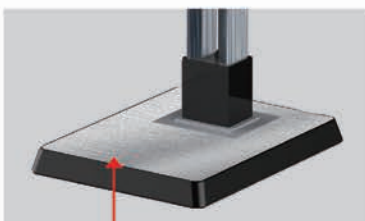

Decorative with brushed panel

Blue indicator light on

- Slight press: Increase time /data
- Long press: Switch 12/24 hour style

Red indicator light on

- Adjust color temperature of main lamp
- 4000K-3000K-6000K(70% brightness in initial status)

Blue indicator light on

- Switch time/date
- When the digit flashing, press "▲" "▼" to adjust data (Switching sequence: Hour-Minute-Year-Month-Date)

Red indicator light on

- Slight press: Adjust brightness for main lamp in four steps(100%-50%-25%-10%)
- Long press: Stepless adjust brightness for main lamp(100%-10%)



Blue indicator light on

- Long press to switch temperature in Celsius/Fahrenheit
- When the digit flashing, press "▲" "▼" to adjust data

Red indicator light on

- Short press: On/Off for Up lighting
- Long press: Stepless dimming for Up light

First step: Long press ON/OFF to switch Red/Blue indicator light

- Blue indicator light on, control LCD display function

Red indicator light on, control main lamp (Slight press to turn on/off main lamp when red indicator light on)

BI-1913-U



Multi-functional LED Floor lamp

Multi-functional LED Floor lamp LCD Display of time,calendar and temperature/
Three CCT/ Stepless dimming/ USB charging/ Supporting tray



BI-1913-U

Power: 12W LED (included)
Voltage: AC100-240V, DC13.5V
Colour Temp: 3000K-4000K-6000K



Gold



Sliver

Double USB charging interface

Multi-functional LED Floor lamp LCD Display of time,calendar and temperature/
Three CCT/ Stepless dimming/ USB charging/ Supporting tray

BI-1913-U

Slant lampshade-large emitting area



Three color temperature adjustment

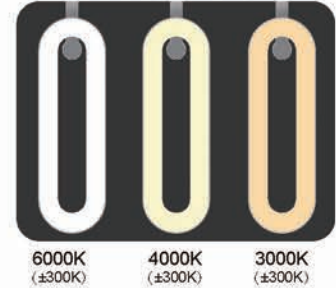

Metal Swivel

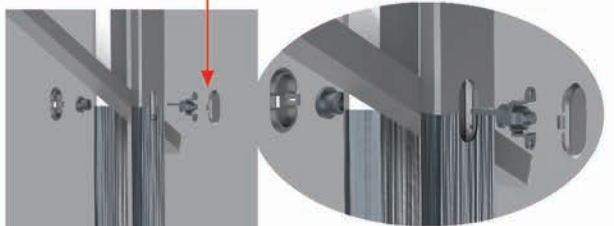

Precise & durable Metal Swivel

Double USB charging interface



Brushed aluminum lamp post



(First step: Long press ON/OFF to switch Red/Blue indicator light)

- Blue indicator light on,control LCD display function
- Red indicator light on,control main lamp

Blue indicator light on

- Slight press: Increase time /data
- Long press: Switch 12/24 hour style

Red indicator light on

- Adjust color temperature of main lamp
- 4000K-3000K-6000K(70% brightness in initial status)

Blue indicator light on

- Switch time/date
- When the digit flashing,press"▲"/"▼" to adjust data (Switching sequence:Hour-Minute-Year-Month-Date)

Red indicator light on

- Slight press: Adjust brightness for main lamp in four steps(100%-50%-25%-10%)
- Long press: Stepless adjust brightness for main lamp(100%-10%)

Blue indicator light on

- Long press to switch temperature in Celsius/Fahrenheit
- When the digit flashing,press"▲"/"▼" to adjust data

Red indicator light on

- Short press: On/Off for Up lighting
- Long press: Stepless dimming for Up lighting

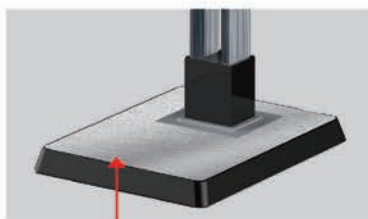

Decorative with brushed panel



- First step: Long press ON/OFF to switch Red/Blue indicator light
- Blue indicator light on,control LCD display function

- Red indicator light on,control main lamp (Slight press to turn on/off main lamp when red indicator light on)

BI-1913-T



Multi-functional LED Floor lamp LCD Display of time, calendar, temperature/ Three CCT/ Stepless dimming



BI-1913-T

Power: 12W LED (included)
Voltage: AC100-240V, DC12V
Colour Temp: 3000K-4000K-6000K



Gold



Sliver

Subject to the color in production at that time,if the colour of product above has been changed.

Multi-functional LED Floor lamp LCD Display of time, calendar, temperature/ Three CCT/ Stepless dimming

BI-1913-T



Slant lampshade-large emitting area

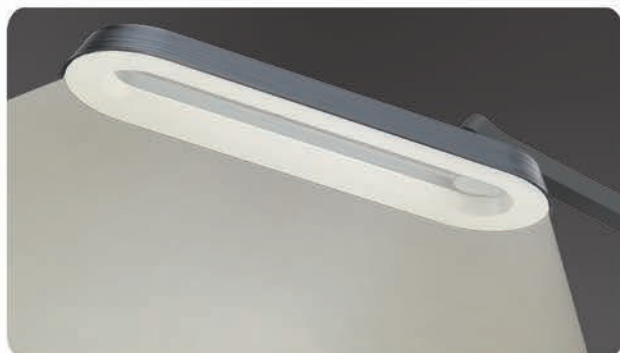

Three color temperature adjustment

6000K
(±300K)

4000K
(±300K)

3000K
(±300K)

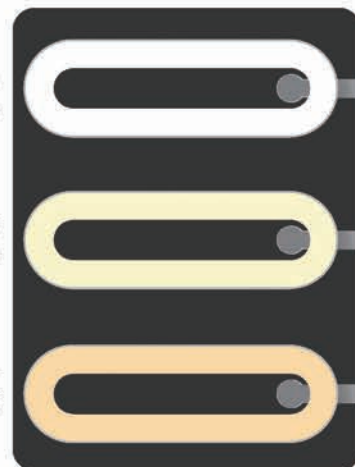

Metal Swivel

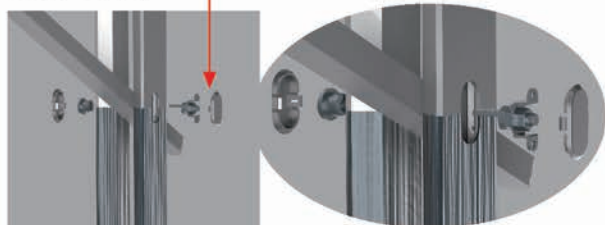

Precise & durable Metal Swivel

Brushed aluminum lamppost



(First step: Long press ON/OFF to switch Red/Blue indicator light)

- Blue indicator light on,control LCD display function
- Red indicator light on,control main lamp

Blue indicator light on

- Slight press: Increase time /data
- Long press: Switch 12/24 hour style

Red indicator light on

- Adjust color temperature of main lamp
- 4000K-3000K-6000K(70% brightness in initial status)

Blue indicator light on

- Switch time/date
- When the digit flashing,press"▲"▼" to adjust data (Switching sequence:Hour-Minute-Year-Month-Date)

Red indicator light on

- Slight press: Adjust brightness for main lamp in four steps(100%-50%-25%-10%)
- Long press: Stepless adjust brightness for main lamp(100%-10%)

Blue indicator light on

- Long press to switch temperature in Celsius/Fahrenheit
- When the digit flashing,press"▲"▼" to adjust data

Red indicator light on

- Short press: On/Off for Up lighting
- Long press: Stepless dimming for Up light

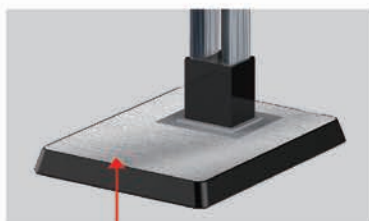

Decorative with brushed panel



First step: Long press ON/OFF to switch Red/Blue indicator light

- Blue indicator light on,control LCD display function

Red indicator light on,control main lamp (Slight press to turn on/off main lamp when red indicator light on)

BI-1913-C



Multi-functional LED Floor lamp

Multi-functional LED Floor lamp LCD Display of time,calendar and temperature/
Three CCT/ Stepless dimming/ Wireless charging/ Supporting tray



BI-1913-C

Power: 15W LED (included)
Voltage: AC100-240V, DC13.5V
Colour Temp: 3000K-4000K-6000K



Gold

Sliver

Portected by patent,if initated will be investigated
Design patent certificate number : 202130597273.X
202130596859.4

Subject to the color in production at that time,if
the colour of product above has been changed.

Multi-functional LED Floor lamp LCD Display of time,calendar and temperature/
Three CCT/ Stepless dimming/ Wireless charging/ Supporting tray

BI-1913-C

Slant lampshade-large emitting area



Three color temperature adjustment

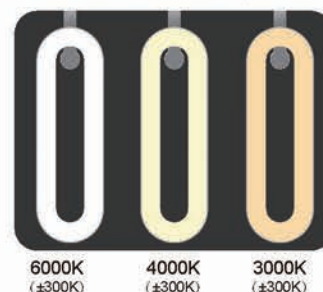

Metal Swivel

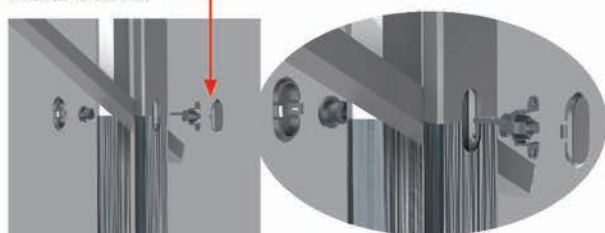

Precise & durable Metal Swivel

Supporting tray with wireless charging



Brushed aluminum lamppost

(First step: Long press ON/OFF to switch Red/Blue indicator light)

- Blue indicator light on,control LCD display function
- Red indicator light on,control main lamp

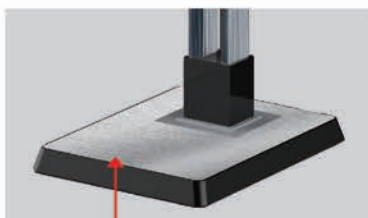

Decorative with brushed panel

Blue indicator light on

- Slight press: Increase time /data
- Long press: Switch 12/24 hour style

Red indicator light on

- Adjust color temperature of main lamp
- 4000K-3000K-6000K(70% brightness in initial status)

Blue indicator light on

- Switch time/date
- When the digit flashing,press"▲"▼" to adjust data (Switching sequence:Hour-Minute-Year-Month-Date)

Red indicator light on

- Slight press: Adjust brightness for main lamp in four steps(100%-50%-25%-10%)
- Long press: Stepless adjust brightness for main lamp(100%-10%)



Blue indicator light on

- Long press to switch temperature in Celsius/Fahrenheit
- When the digit flashing,press"▲"▼" to adjust data

Red indicator light on

- Short press: On/Off for Up lighting
- Long press: Stepless dimming for Up light

First step: Long press ON/OFF to switch Red/Blue indicator light

- Blue indicator light on,control LCD display function
- Red indicator light on,control main lamp (Slight press to turn on/off main lamp when red indicator light on)



BI-1925 Multi-functional LED Floor lamp



BI-1925

- Infrared remote control
- Double luminaire
- Three CCT
- Stepless dimming

COLOR:
White, Black, Grey



BI-1925-P

- Infrared remote control
- Supporting tray
- Double luminaire
- Three CCT
- Stepless dimming

COLOR:
White, Black, Grey



BI-1925-U

- Infrared remote control
- Supporting tray
- USB charging
- Double luminaire
- Three CCT
- Stepless dimming

COLOR:
White, Black, Grey



BI-1925-C

- Infrared remote control
- Supporting tray
- Wireless charging
- Double luminaire
- Three CCT
- Stepless dimming

COLOR:
White, Black, Grey





BI-1925



Multi-functional LED Floor lamp

Multi-functional LED Floor lamp Infrared remote control/
Double luminaire/ Three CCT/ Stepless dimming



BI-1925

Power: 15W LED (included)
Voltage: AC100-240V, DC12V
Colour Temp: 3000K-4000K-6000K



White

Infrared remote control

Black

Portected by patent,if imitated will be investigating
Design patent certificate number : 202130178386.6

Multi-functional LED Floor lamp Infrared remote control/
Double luminaire/ Three CCT/ Stepless dimming

BI-1925



Up lighting --- CCT & Dimming control for up lighting

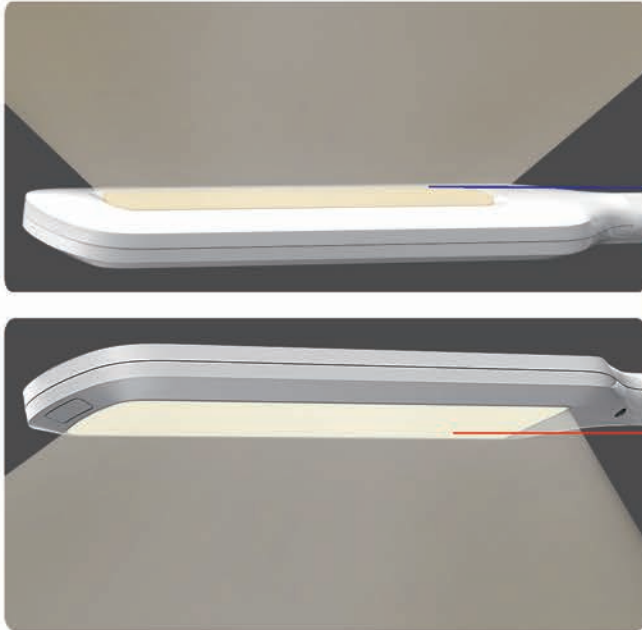

Up lighting

UP-ON / OFF UP-CCT/DIM

Down lighting

brightness+ brightness-

ON / OFF

CCT

Down lighting --- CCT & Dimming control for down lighting

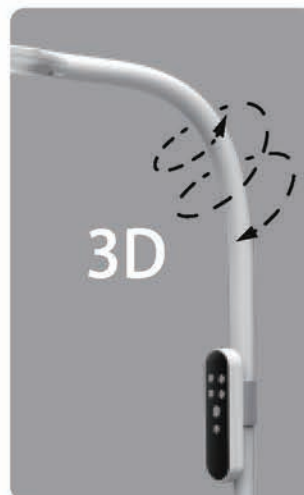
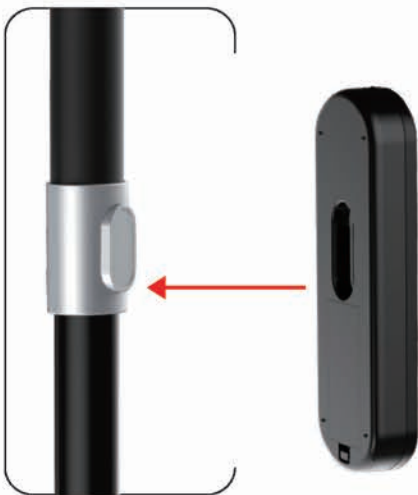

silicone hose design 360° rotating

Infrared remote control

- The remote control can be separated from the lamp body
- The effective distance of remote control is about 5 meters
- The remote control and lamp body are connected by magnet, it is easy for using.

Three color temperature adjustment

6000K
(±300K)

4000K
(±300K)

3000K
(±300K)



Subject to the color in production at that time,if the colour of product above has been changed.



BI-1925-P



Multi-functional LED Floor lamp Infrared remote control/ Double luminaire/
Three CCT/Stepless dimming/ Supporting tray



BI-1925-P

Power: 15W LED (included)
Voltage: AC100-240V, DC12V
Colour Temp: 3000K-4000K-6000K



Infrared remote control

With supporting tray

White

Black

Subject to the color in production at that time, if the colour of product above has been changed.

Multi-functional LED Floor lamp Infrared remote control/ Double luminaire/
Three CCT/Stepless dimming/ Supporting tray

BI-1925-P



Up lighting --- CCT & Dimming control for up lighting

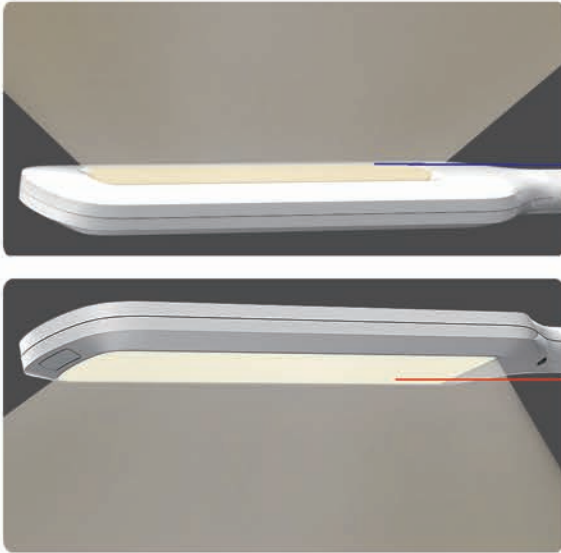

Up lighting

UP-ON / OFF

UP-CCT/DIM

Down lighting

brightness+

brightness-

ON / OFF

CCT

Down lighting --- CCT & Dimming control for down lighting

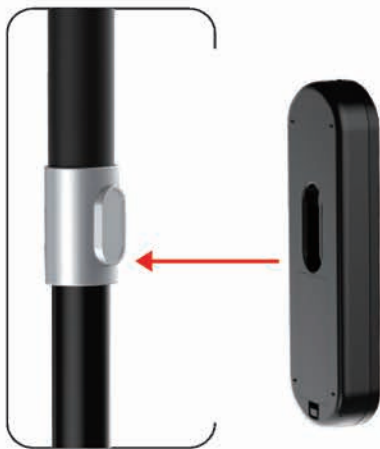

With supporting tray



Infrared remote control

- The remote control can be separated from the lamp body
- The effective distance of remote control is about 5 meters
- The remote control and lamp body are connected by magnet, it is easy for using.

silicone hose design 360° rotating



Three color temperature adjustment



6000K
(±300K)

4000K
(±300K)

3000K
(±300K)



BI-1925-U



Multi-functional LED Floor lamp

Multi-functional LED Floor lamp Infrared remote control. Double luminaire/
Three CCT/ Stepless dimming/ USB charging/ Supporting tray



BI-1925-U

Power: 15W LED (included)

Voltage: AC100-240V, DC13.5V

Colour Temp: 3000K-4000K-6000K



Multi-functional LED Floor lamp Infrared remote control. Double luminaire/
Three CCT/ Stepless dimming/ USB charging/ Supporting tray

BI-1925-U



Up lighting --- CCT & Dimming control for up lighting

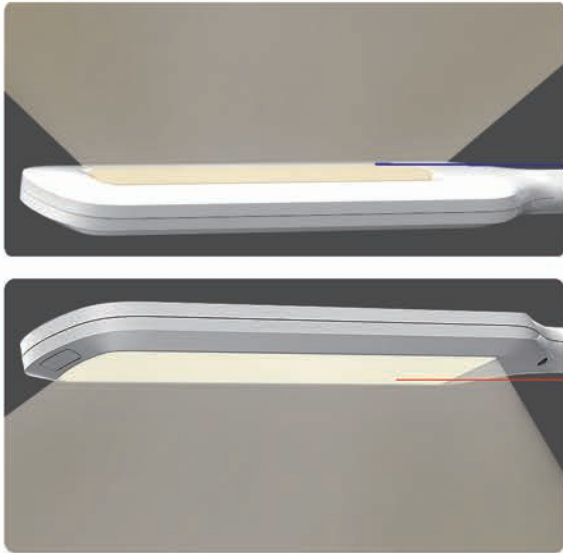

Up lighting

UP-ON / OFF

UP-CCT/DIM

Down lighting

brightness+

brightness-

ON / OFF

CCT

Down lighting --- CCT & Dimming control for down lighting

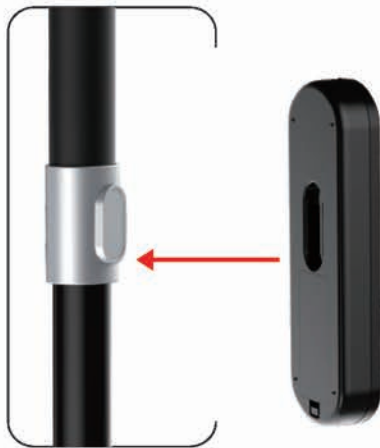

Double USB charging interface



silicone hose design 360° rotating



Three color temperature adjustment

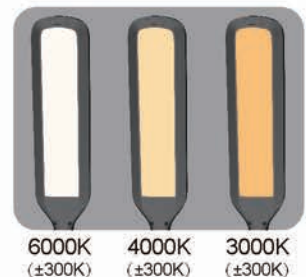

- Infrared remote control**
- The remote control can be separated from the lamp body
 - The effective distance of remote control is about 5 meters
 - The remote control and lamp body are connected by magnet, it is easy for using.

Subject to the color in production at that time, if the colour of product above has been changed.



BI-1925-C



Multi-functional LED Floor lamp Infrared remote control/ Double luminaire/
Three CCT / Stepless dimming/ Wireless charging/ Supporting tray



BI-1925-C

Power: 15W LED (included)
Voltage: AC100-240V, DC13.5V
Colour Temp: 3000K-4000K-6000K



White



Infrared remote control

Supporting tray with wireless charging

Black

Portected by patent,if initated will be investigated
Design patent certificate number : 202130597274.4
202130597238.8

Subject to the color in production at that time,if the colour of product above has been changed.

Multi-functional LED Floor lamp Infrared remote control/ Double luminaire/
Three CCT / Stepless dimming/ Wireless charging/ Supporting tray

BI-1925-C



Up lighting --- CCT & Dimming control for up lighting

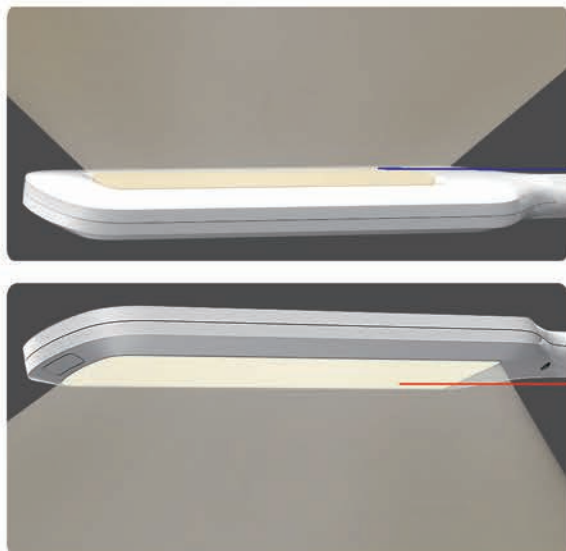

Up lighting

UP-ON / OFF

UP-CCT/DIM

Down lighting

brightness+

brightness-

ON / OFF

CCT

Down lighting --- CCT & Dimming control for down lighting

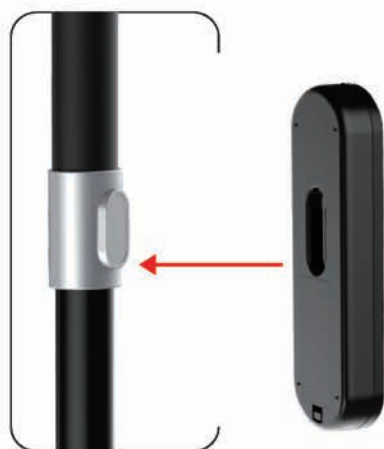

Supporting tray with wireless charging



silicone hose design 360° rotating

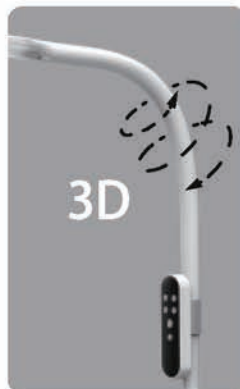

Infrared remote control

- The remote control can be separated from the lamp body
- The effective distance of remote control is about 5 meters
- The remote control and lamp body are connected by magnet, it is easy for using.

Three color temperature adjustment

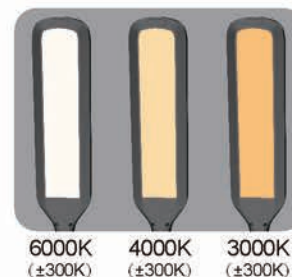



BI-1926 Multi-functional LED Floor lamp



BI-1926

- Three CCT
- Stepless dimming

COLOR:
Silver, Grey, Champagne Gold



BI-1926-P

- LCD Display of time, calendar, temperature
- Supporting tray
- Three CCT
- Stepless dimming

COLOR:
Silver, Grey, Champagne Gold



BI-1926-U

- LCD Display of time, calendar, temperature
- Supporting tray
- USB charging
- Three CCT
- Stepless dimming

COLOR:
Silver, Grey, Champagne Gold



BI-1926-T

- LCD Display of time, calendar, temperature
- Three CCT
- Stepless dimming

COLOR:
Silver, Grey, Champagne Gold



BI-1926-C

- LCD Display of time, calendar, temperature
- Supporting tray
- Wireless charging
- Three CCT
- Stepless dimming

COLOR:
Silver, Grey, Champagne Gold



Multi-functional LED Floor lamp Three CCT/ Stepless dimming



BI-1926

Power: 12W LED (included)

Voltage: AC100-240V, DC12V

Colour Temp: 3000K-4000K-6000K



Gold

Sliver

Portected by patent,if imitated will be investigating

Design patent certificate number : 202130363690.8

Subject to the color in production at that time,if the colour of product above has been changed.

Multi-functional LED Floor lamp Three CCT/ Stepless dimming

BI-1926



Slant lampshade-large emitting area

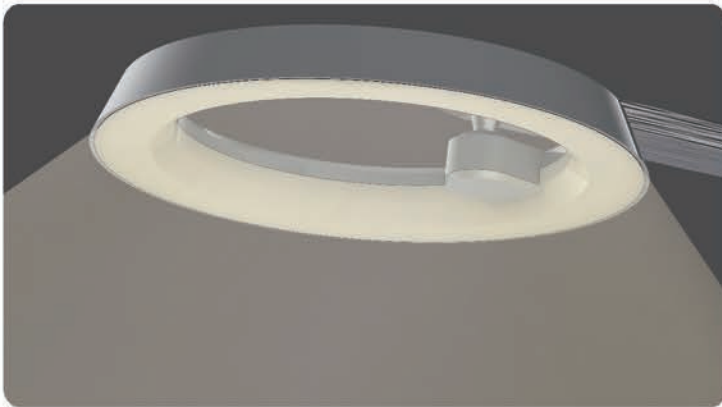

Metal Swivel

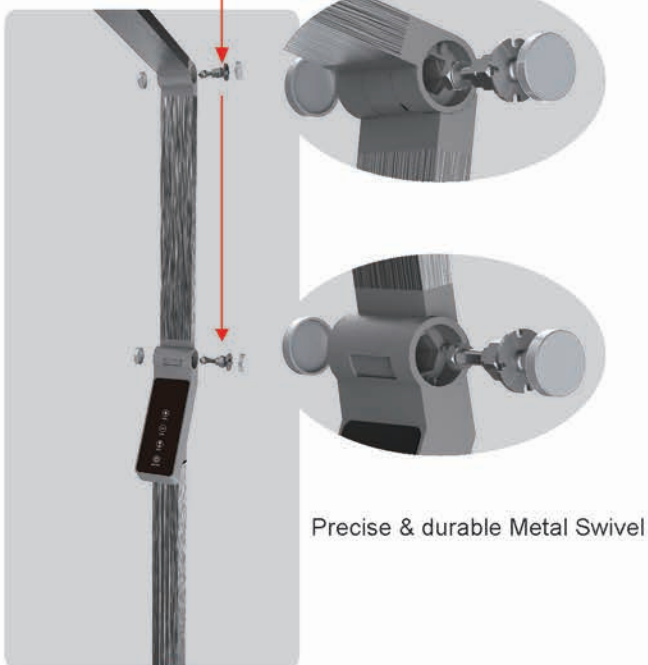

Precise & durable Metal Swivel

Brushed aluminum lamppost

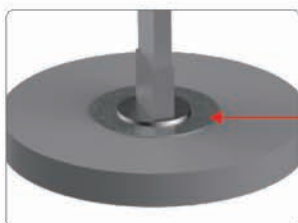

Decorative with brushed panel

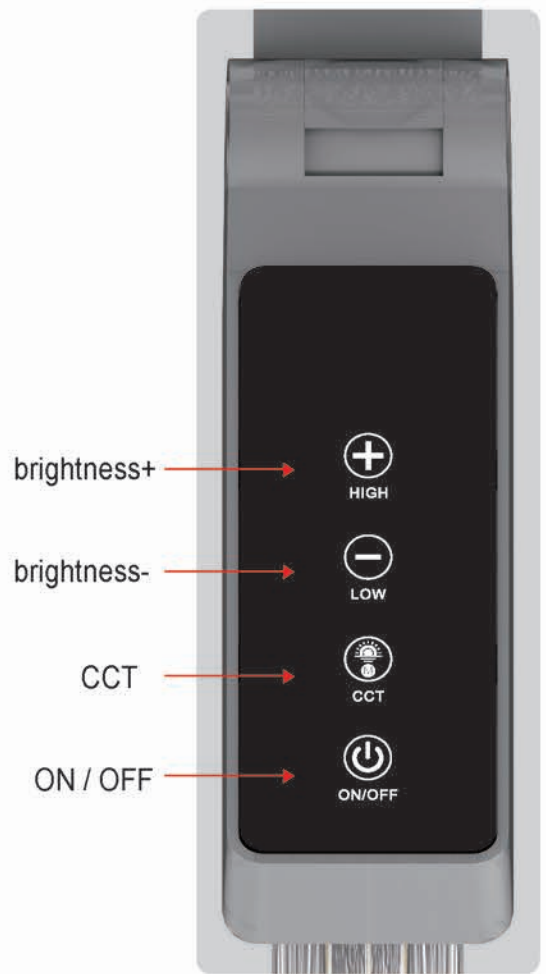

brightness+



HIGH

brightness-



LOW

CCT



CCT

ON / OFF



ON/OFF

Three color temperature adjustment

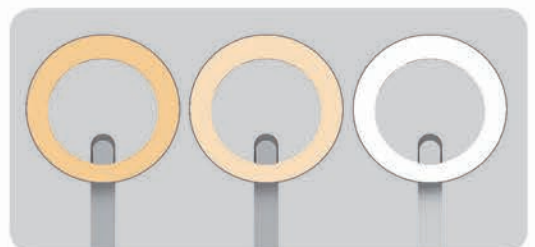

3000K
(±300K)

4000K
(±300K)

6000K
(±300K)

BI-1926-P



Multi-functional LED Floor lamp

Multi-functional LED Floor lamp LCD display of time/
Three CCT/ Stepless dimming/ Supporting tray



BI-1926-P

Power: 12W LED (included)
Voltage: AC100-240V, DC12V
Colour Temp: 3000K-4000K-6000K



Multi-functional LED Floor lamp LCD display of time/
Three CCT/ Stepless dimming/ Supporting tray

BI-1926-P



Slant lampshade-large emitting area

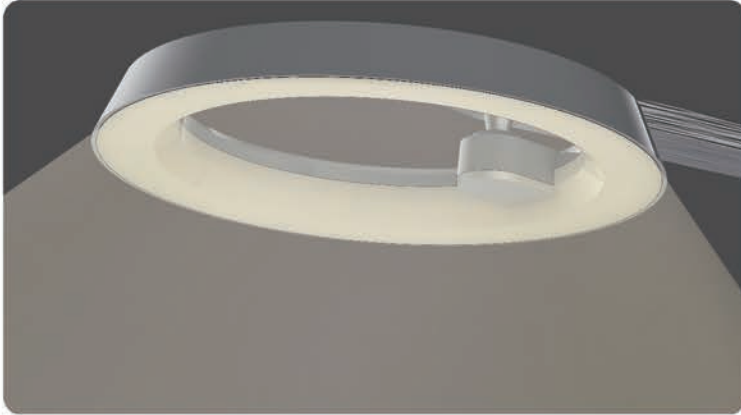

Metal Swivel

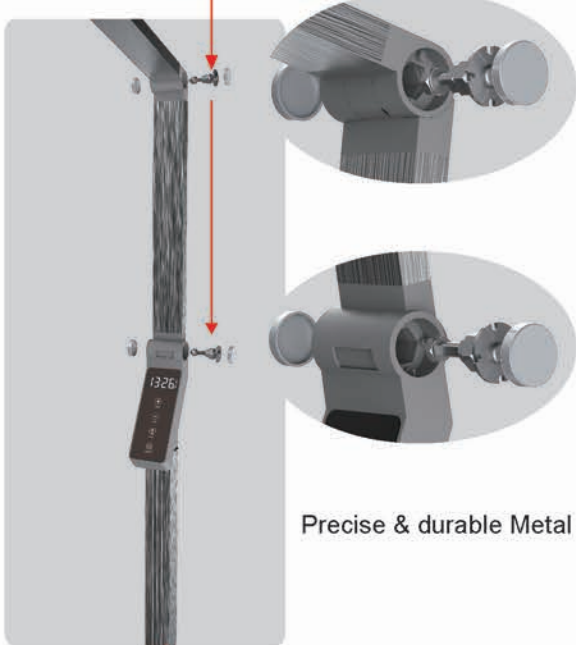

Precise & durable Metal Swivel

Brushed aluminum lamppost

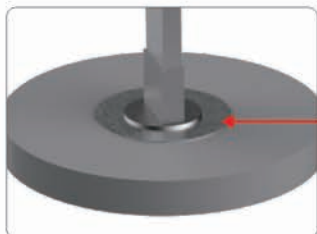

Decorative with brushed panel

With supporting tray



Three color temperature adjustment

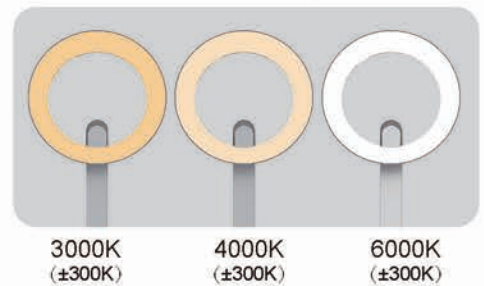

Subject to the color in production at that time, if the colour of product above has been changed.

BI-1926-U



Multi-functional LED Floor lamp LCD display of time/ Three CCT/
Stepless dimming / USB charging/ Supporting tray



BI-1926-U

Power: 12W LED (included)
Voltage: AC100-240V, DC13.5V
Colour Temp: 3000K-4000K-6000K



Gold

Sliver

Double USB charging interface

Subject to the color in production at that time,if the colour of product above has been changed.

Multi-functional LED Floor lamp LCD display of time/ Three CCT/ Stepless dimming / USB charging/ Supporting tray

BI-1926-U



Slant lampshade-large emitting area

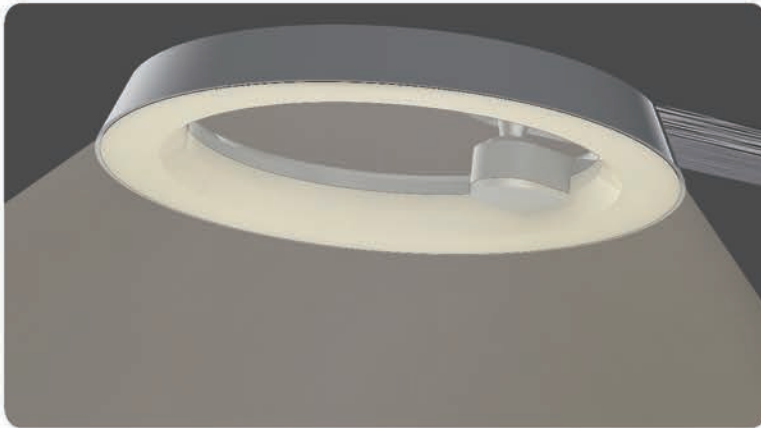

brightness+ → HIGH

brightness- → LOW

CCT → CCT

ON / OFF → ON/OFF

Metal Swivel

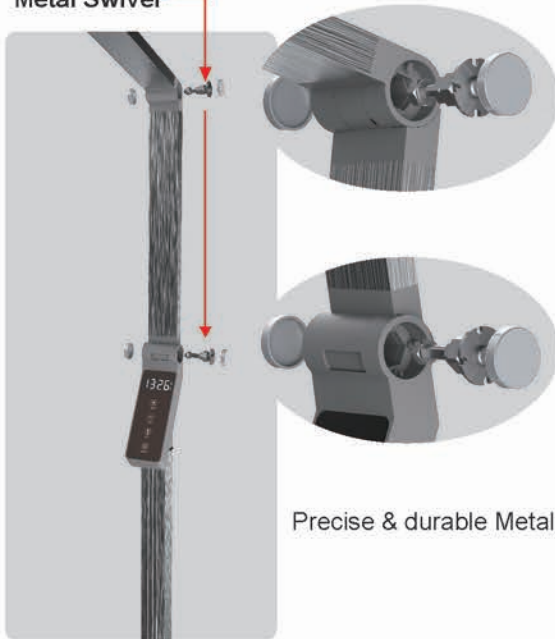

Precise & durable Metal Swivel

Brushed aluminum lamppost

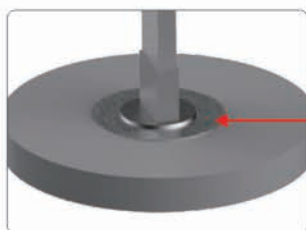

Decorative with brushed panel

Double USB charging interface



Three color temperature adjustment

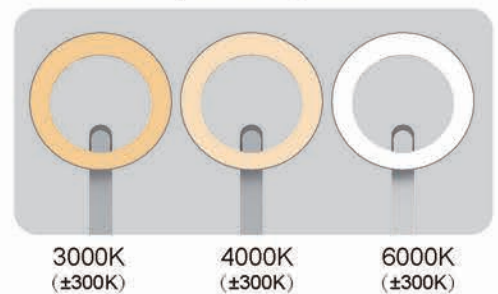



BI-1926-T



Multi-functional LED Floor lamp

Multi-functional LED Floor lamp
LCD display of time/ Three CCT/ Stepless dimming



BI-1926-T

Power: 12W LED (included)
Voltage: AC100-240V, DC12V
Colour Temp: 3000K-4000K-6000K



Gold



Sliver

Multi-functional LED Floor lamp
LCD display of time/ Three CCT/ Stepless dimming

BI-1926-T



Slant lampshade-large emitting area



Metal Swivel

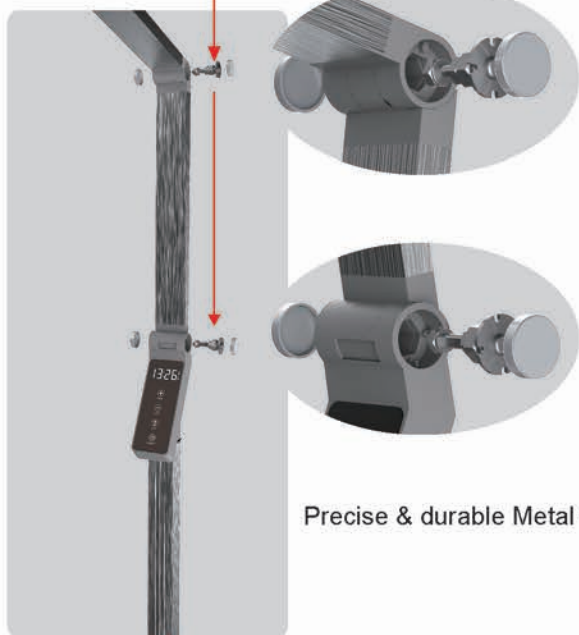

Precise & durable Metal Swivel

Brushed aluminum lamppost

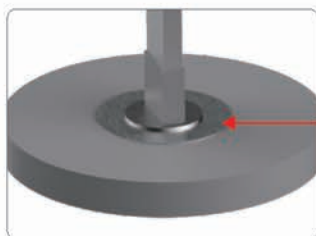

Decorative with brushed panel



Three color temperature adjustment

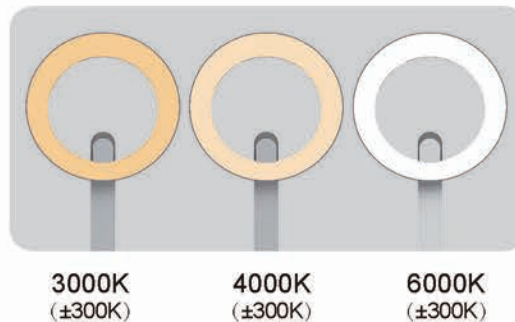

Subject to the color in production at that time, if the colour of product above has been changed.



BI-1926-C



Multi-functional LED Floor lamp LCD display of time/ Three CCT/
Stepless dimming/ Wireless charging/ Supporting tray



BI-1926-C

Power: 12W LED (included)
Voltage: AC100-240V, DC13.5V
Colour Temp: 3000K-4000K-6000K



Supporting tray with wireless charging

Gold

Sliver

Portected by patent,if initated will be investigating
Design patent certificate number : 202130597260.2
202130597233.5

Subject to the color in production at that time,if the colour of product above has been changed.

Multi-functional LED Floor lamp LCD display of time/ Three CCT/ Stepless dimming/ Wireless charging/ Supporting tray

BI-1926-C



Slant lampshade-large emitting area

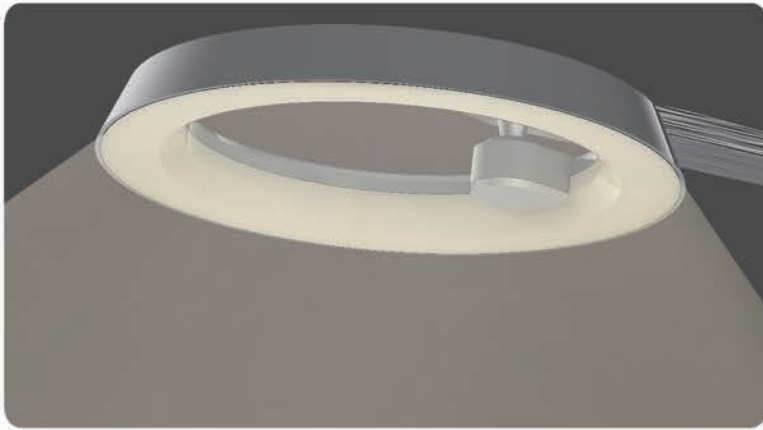

brightness+ HIGH
brightness- LOW
CCT
ON / OFF ON/OFF

Metal Swivel

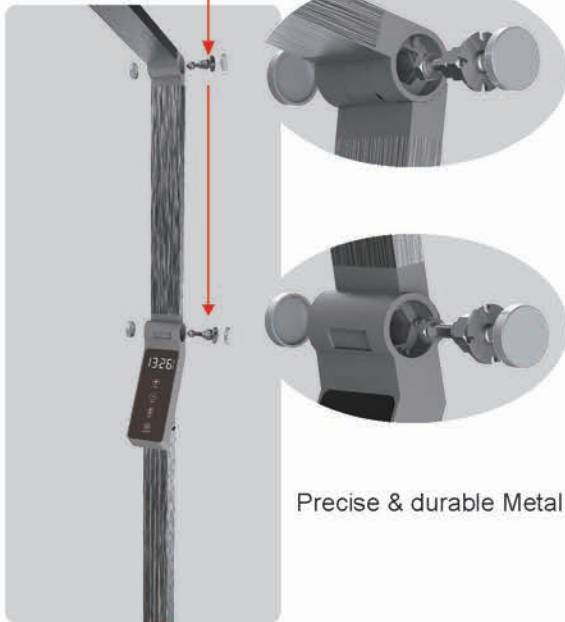

Precise & durable Metal Swivel



Supporting tray with wireless charging

Brushed aluminum lamppost

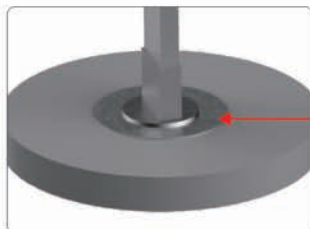

Decorative with brushed panel

Three color temperature adjustment

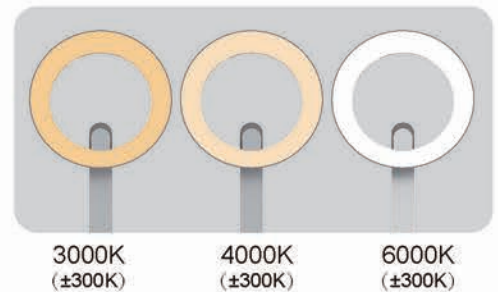

BI-1927 Multi-functional LED Floor lamp



BI-1927

- **Double luminaire**
- Three CCT
- Stepless sliding dimming

COLOR:
White, Black, Grey



BI-1927-P

- **Supporting tray**
- **Double luminaire**
- Three CCT
- Stepless sliding dimming

COLOR:
White, Black, Grey



BI-1927-U

- **Supporting tray**
- **USB charging**
- **Double luminaire**
- Three CCT
- Stepless sliding dimming

COLOR:
White, Black, Grey



BI-1927-C

- **Supporting tray**
- **Wireless charging**
- **Double luminaire**
- Three CCT
- Stepless sliding dimming

COLOR:
White, Black, Grey





BI-1927



Multi-functional LED Floor lamp
Double luminaire/ Three CCT/ Stepless sliding dimming



BI-1927

Power: 15W LED (included)
Voltage: AC100-240V, DC12V
Colour Temp: 3000K-4000K-6000K



White



White



Black

Portected by patent,if initated will be investigated
Design patent certificate number : 202130597256.6

Subject to the color in production at that time,if
the colour of product above has been changed.

Multi-functional LED Floor lamp Double luminaire/ Three CCT/ Stepless sliding dimming

BI-1927

Up lighting

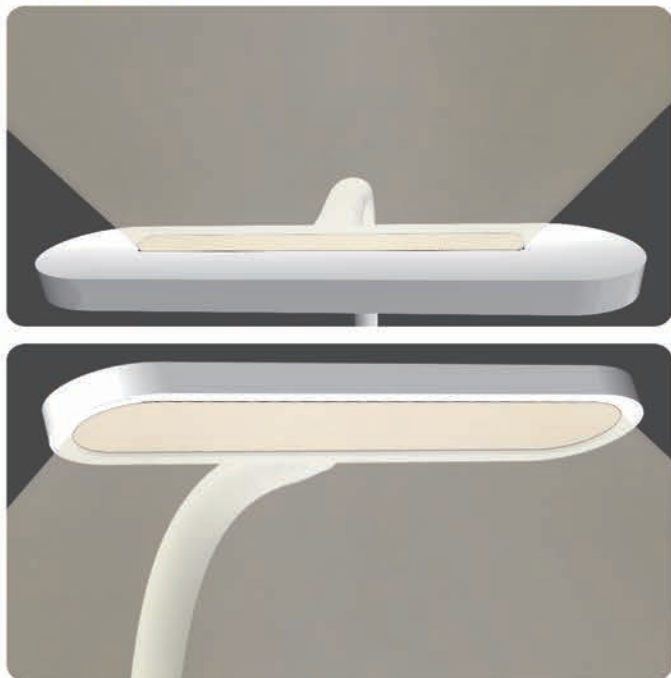

silicone hose design 360° rotating

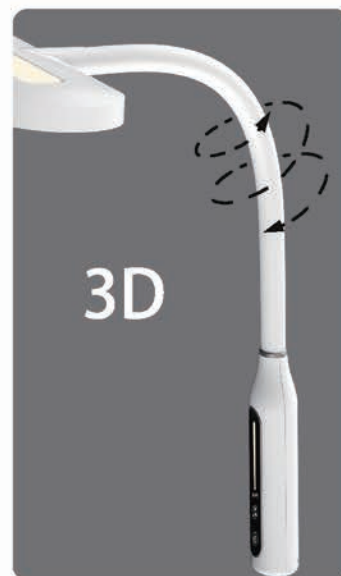

Down lighting

Three color temperature adjustment

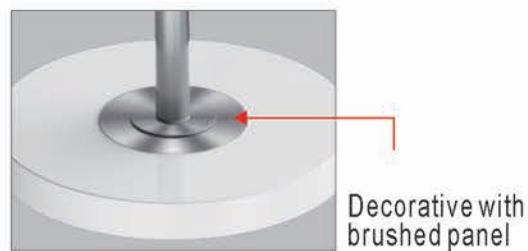
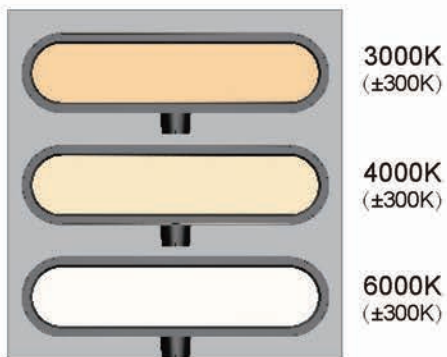

Sliding stepless dimming to adjust the brightness of the light

Short press: On/Off for Up lighting
 Long press: Stepless dimming for Up light



BI-1927-P



Multi-functional LED Floor lamp

Multi-functional LED Floor lamp Double luminaire/ Three CCT/
Stepless sliding dimming/ Supporting tray



BI-1927-P

Power: 15W LED (included)
Voltage: AC100-240V, DC12V
Colour Temp: 3000K-4000K-6000K



White



Grey



Black

Multi-functional LED Floor lamp Double luminaire/ Three CCT/ Stepless sliding dimming/ Supporting tray

BI-1927-P

Up lighting

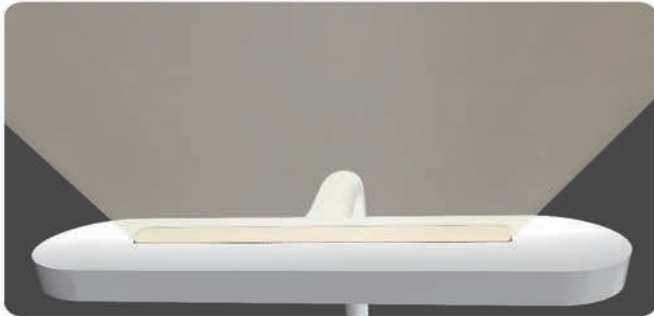

Down lighting



With supporting tray

Three color temperature adjustment

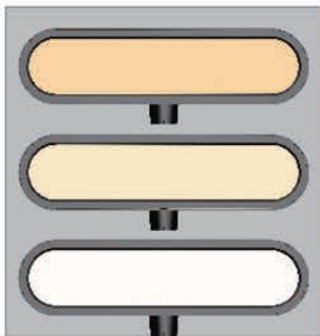

3000K (±300K)

4000K (±300K)

6000K (±300K)

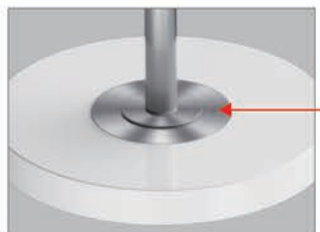

Decorative with brushed panel

Sliding stepless dimming to adjust the brightness of the light



Short press: On/Off for Up lighting
Long press: Stepless dimming for Up light

CCT
ON / OFF

silicone hose design 360° rotating

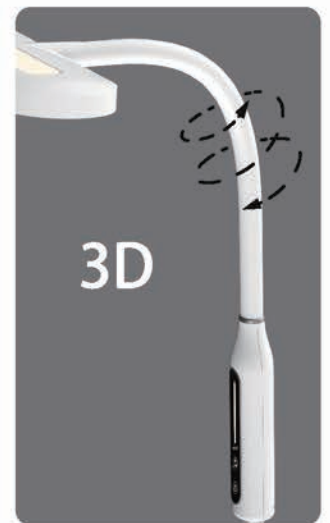

3D

Subject to the color in production at that time, if the colour of product above has been changed.



BI-1927-U



Multi-functional LED Floor lamp Double luminaire/ Three CCT/
Stepless sliding dimming/ USB charging/ Supporting tray



BI-1927-U

Power: 15W LED (included)
Voltage: AC100-240V, DC13.5V
Colour Temp: 3000K-4000K-6000K



Double USB
charging interface

Black



Grey



White

Subject to the color in production at that time,if the colour of product above has been changed.

Multi-functional LED Floor lamp Double luminaire/ Three CCT/ Stepless sliding dimming/ USB charging/ Supporting tray

BI-1927-U

Up lighting

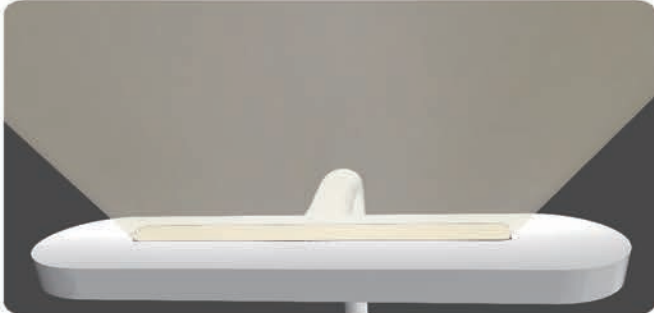

Down lighting



Double USB charging interface

Three color temperature adjustment

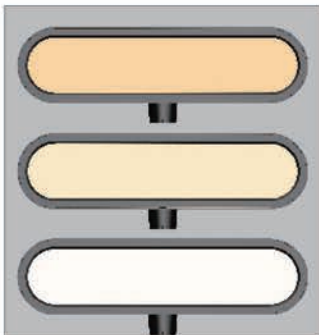

3000K (±300K)

4000K (±300K)

6000K (±300K)

Sliding stepless dimming to adjust the brightness of the light



Short press: On/Off for Up lighting
Long press: Stepless dimming for Up light

CCT

ON / OFF

silicone hose design 360° rotating

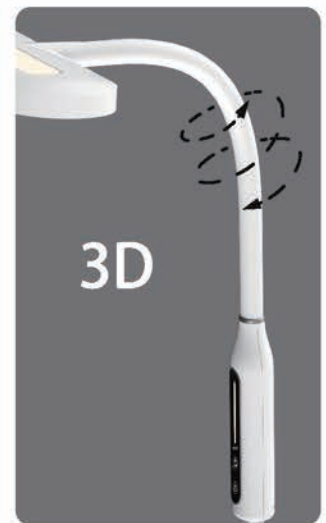

3D

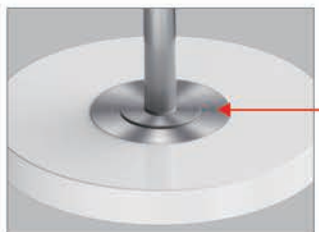

Decorative with brushed panel



BI-1927-C



Multi-functional LED Floor lamp

Multi-functional LED Floor lamp Double luminaire/ Three CCT/
Stepless sliding dimming/ Wireless charging/ Supporting tray



BI-1927-C

Power: 15W LED (included)
Voltage: AC100-240V, DC13.5V
Colour Temp: 3000K-4000K-6000K



Supporting tray with
wireless charging

Black



White



Grey

Portected by patent,if imitated will be investigating
Design patent certificate number : 202130363832.0
202130596847.1

Multi-functional LED Floor lamp Double luminaire/ Three CCT/ Stepless sliding dimming/ Wireless charging/ Supporting tray

BI-1927-C

Up lighting

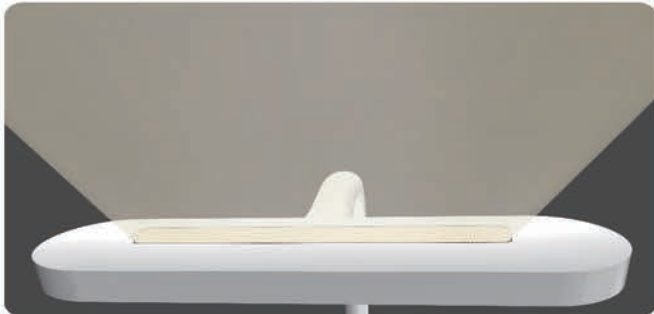

Down lighting



Supporting tray with wireless charging

Three color temperature adjustment

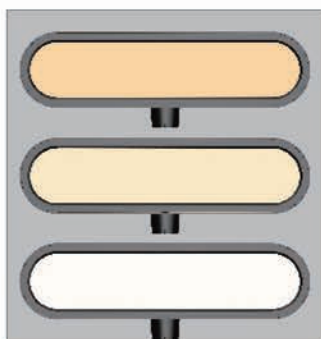

3000K (±300K)

4000K (±300K)

6000K (±300K)

Sliding stepless dimming to adjust the brightness of the light



Short press: On/Off for Up lighting
Long press: Stepless dimming for Up light

CCT
ON / OFF

silicone hose design 360° rotating

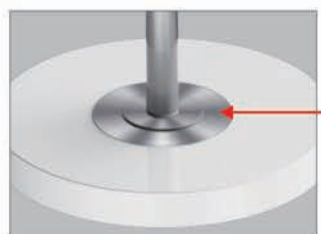
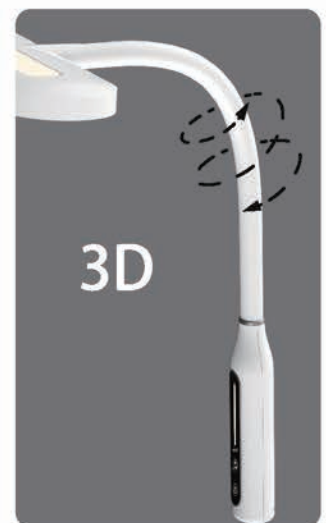

Decorative with brushed panel

Subject to the color in production at that time, if the colour of product above has been changed.



BI-1928 Multi-functional LED Floor lamp



BI-1928

- Double luminaire
- Three CCT
- Stepless dimming

COLOR:
Silver, Grey, Champagne Gold



BI-1928-P

- Double luminaire
- LCD Display of time, calendar, temperature
- Supporting tray
- Three CCT
- Stepless dimming

COLOR:
Silver, Grey, Champagne Gold



BI-1928-U

- Double luminaire
- LCD Display of time, calendar, temperature
- Supporting tray
- USB charging
- Three CCT
- Stepless dimming

COLOR:
Silver, Grey, Champagne Gold



BI-1928-T

- Double luminaire
- LCD Display of time, calendar, temperature
- Three CCT
- Stepless dimming

COLOR:
Silver, Grey, Champagne Gold



BI-1928-C

- Double luminaire
- LCD Display of time, calendar, temperature
- Supporting tray
- Wireless charging
- Three CCT
- Stepless dimming

COLOR:
Silver, Grey, Champagne Gold

BI-1928



Multi-functional LED Floor lamp

Multi-functional LED Floor lamp
Double luminaire/ Three CCT/ Stepless dimming.



BI-1928

Power: 15W LED (included)
Voltage: AC100-240V, DC12V
Colour Temp: 3000K-4000K-6000K



White



Grey



Black

Portected by patent,if imitated will be investigated
Design patent certificate number : 202130363687.6

Multi-functional LED Floor lamp
Double luminaire/ Three CCT/ Stepless dimming.

BI-1928

Up lighting

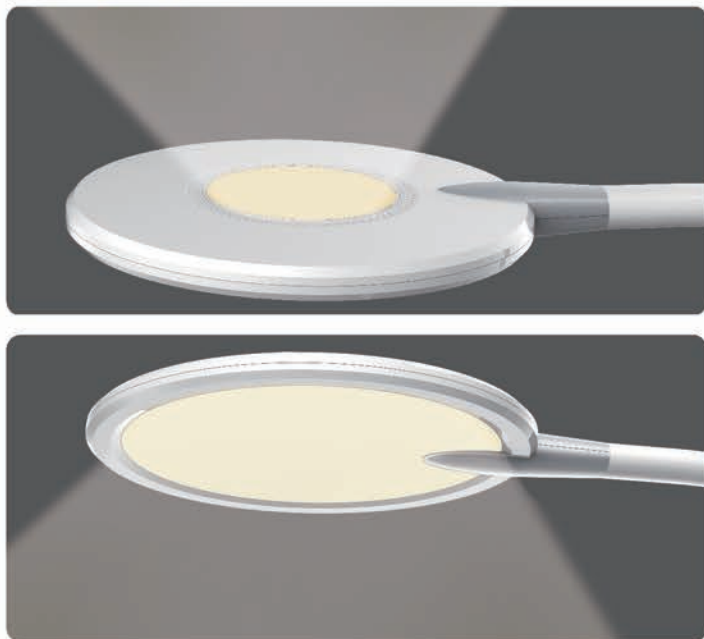

三色温调节

Three color temperature adjustment



3000K
(±300K)



4000K
(±300K)



6000K
(±300K)



Down lighting

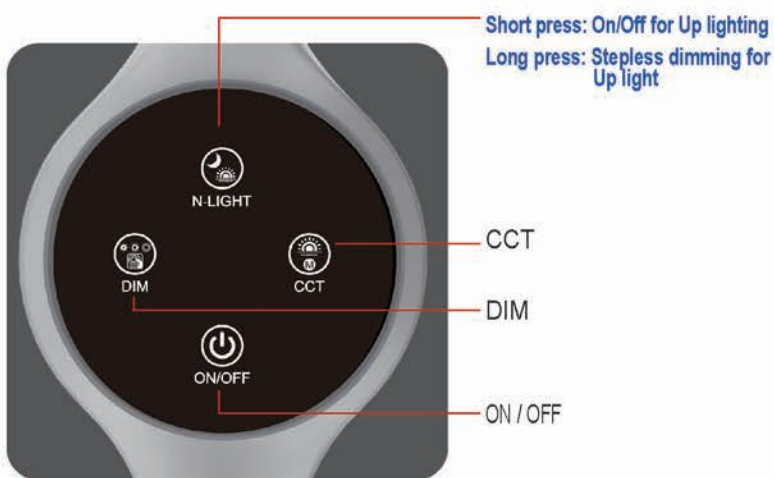

Short press: On/Off for Up lighting
Long press: Stepless dimming for Up light

CCT

DIM

ON / OFF

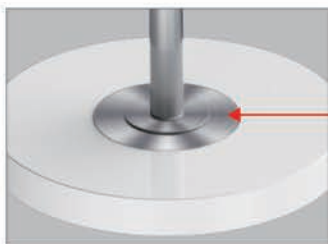

Decorative with brushed panel

silicone hose design 360° rotating



3D

Brushed aluminum lamp post

Subject to the color in production at that time, if the colour of product above has been changed.



BI-1928-P

Multi-functional LED Floor lamp LCD display of time, calendar, temperature/
Double luminaire/ Three CCT/ Stepless dimming/ Supporting tray



BI-1928-P

Power: 15W LED (included)
Voltage: AC100-240V, DC12V
Colour Temp: 3000K-4000K-6000K



White

Grey

Black

With supporting tray

Subject to the color in production at that time, if the colour of product above has been changed.

Multi-functional LED Floor lamp LCD display of time, calendar, temperature/
Double luminaire/ Three CCT/ Stepless dimming/ Supporting tray

BI-1928-P

Up lighting

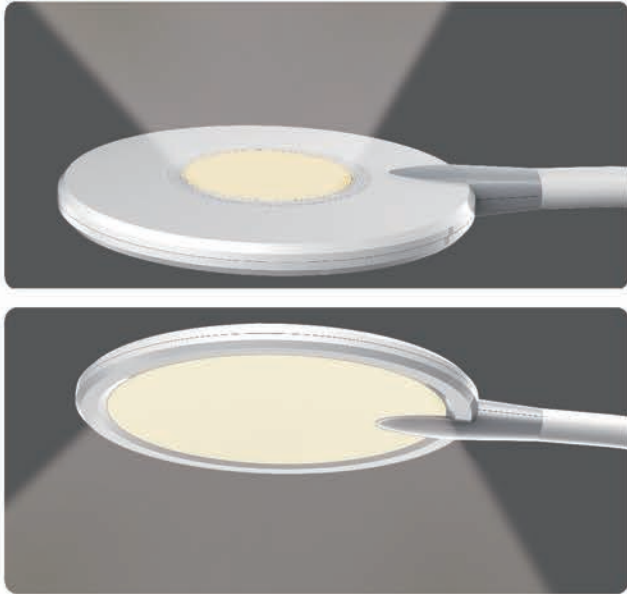

Down lighting

(First step: Long press ON/OFF to switch Red/Blue indicator light)

- Blue indicator light on,control LCD display function
- Red indicator light on,control main lamp

Blue indicator light on

- Slight press: Increase time /data
- Long press: Switch 12/24 hour style

Red indicator light on

- Adjust color temperature of main lamp
- 4000K-3000K-6000K(70% brightness in initial status)

Blue indicator light on

- Switch time/date
- When the digit flashing,press"▲"/"▼" to adjust data (Switching sequence:Hour-Minute-Year-Month-Date)

Red indicator light on

- Slight press: Adjust brightness for main lamp in four steps(100%-50%-25%-10%)
- Long press: Stepless adjust brightness for main lamp(100%-10%)



Blue indicator light on

- Long press to switch temperature in Celsius/Fahrenheit
- When the digit flashing,press"▲"/"▼" to adjust data

Red indicator light on

- Short press: On/Off for Up lighting
- Long press: Stepless dimming for Up light

First step: Long press ON/OFF to switch Red/Blue indicator light

- Blue indicator light on,control LCD display function

- Red indicator light on,control main lamp (Slight press to turn on/off main lamp when red indicator light on)



silicone hose design 360° rotating



3D

With supporting tray

Brushed aluminum lamppost

Three color temperature adjustment

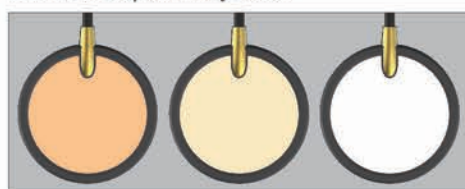

3000K
(±300K)

4000K
(±300K)

6000K
(±300K)

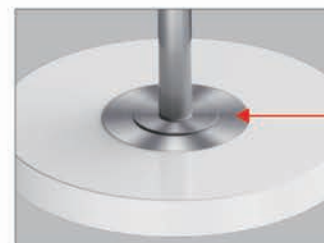

Decorative with brushed panel

BI-1928-U



Multi-functional LED Floor lamp

Multi-functional LED Floor lamp LCD display of time, calendar, temperature/
Double luminaire/ Three CCT/ Stepless dimming/ USB charging/ Supporting tray



BI-1928-U

Power: 15W LED (included)
Voltage: AC100-240V, DC13.5V
Colour Temp: 3000K-4000K-6000K



White

Black

Grey

Double USB charging interface

Multi-functional LED Floor lamp LCD display of time, calendar, temperature/
Double luminaire/ Three CCT/ Stepless dimming/ USB charging/ Supporting tray

BI-1928-U

Up lighting

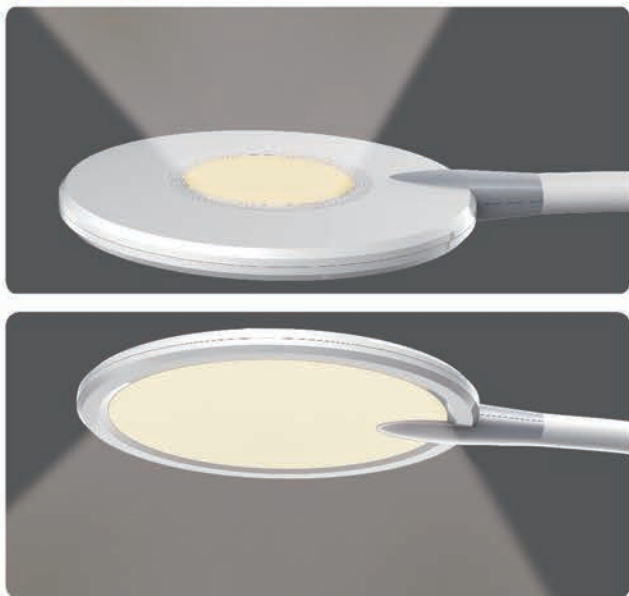

Down lighting

(First step: Long press ON/OFF to switch Red/Blue indicator light)

- Blue indicator light on,control LCD display function
- Red indicator light on,control main lamp

Blue indicator light on

- Slight press: Increase time /data
- Long press: Switch 12/24 hour style

Red indicator light on

- Adjust color temperature of main lamp
- 4000K-3000K-6000K(70% brightness in initial status)

Blue indicator light on

- Switch time/date
- When the digit flashing,press"▲"▼"▼" to adjust data (Switching sequence:Hour-Minute-Year-Month-Date)

Red indicator light on

- Slight press: Adjust brightness for main lamp in four steps(100%-50%-25%-10%)
- Long press: Stepless adjust brightness for main lamp(100%-10%)



Blue indicator light on

- Long press to switch temperature in Celsius/Fahrenheit
- When the digit flashing,press"▲"▼" to adjust data

Red indicator light on

- Short press: On/Off for Up lighting
- Long press: Stepless dimming for Up light

First step: Long press ON/OFF to switch Red/Blue indicator light

- Blue indicator light on,control LCD display function

- Red indicator light on,control main lamp (Slight press to turn on/off main lamp when red indicator light on)



silicone hose design 360° rotating



Brushed aluminum lamp post

Three color temperature adjustment

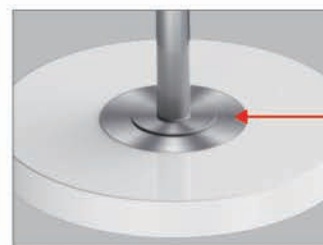

Decorative with brushed panel

Subject to the color in production at that time,if the colour of product above has been changed.



BI-1928-T



Multi-functional LED Floor lamp LCD display of time, calendar, temperature/
Double luminaire/ Three CCT/ Stepless dimming



BI-1928-T

Power: 15W LED (included)
Voltage: AC100-240V, DC12V
Colour Temp: 3000K-4000K-6000K



White



Grey



Black

Subject to the color in production at that time, if the colour of product above has been changed.

Multi-functional LED Floor lamp LCD display of time, calendar, temperature/
Double luminaire/ Three CCT/ Stepless dimming

BI-1928-T

Up lighting

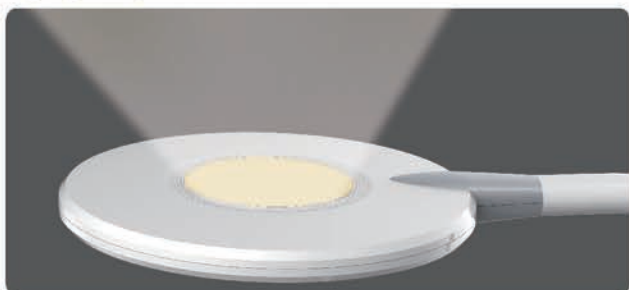

silicone hose design 360° rotating



Brushed aluminum lamppost

Down lighting

(First step: Long press ON/OFF to switch Red/Blue indicator light)

- Blue indicator light on,control LCD display function
- Red indicator light on,control main lamp

Blue indicator light on

- Slight press: Increase time /data
- Long press: Switch 12/24 hour style

Red indicator light on

- Adjust color temperature of main lamp
- 4000K-3000K-6000K(70% brightness in initial status)

Blue indicator light on

- Switch time/date
- When the digit flashing,press"▲"/"▼" to adjust data (Switching sequence:Hour-Minute-Year-Month-Date)

Red indicator light on

- Slight press: Adjust brightness for main lamp in four steps(100%-50%-25%-10%)
- Long press: Stepless adjust brightness for main lamp(100%-10%)



Blue indicator light on

- Long press to switch temperature in Celsius/Fahrenheit
- When the digit flashing,press"▲"/"▼" to adjust data

Red indicator light on

- Short press: On/Off for Up lighting
- Long press: Stepless dimming for Up light

First step: Long press ON/OFF to switch Red/Blue indicator light

- Blue indicator light on,control LCD display function

- Red indicator light on,control main lamp (Slight press to turn on/off main lamp when red indicator light on)

Three color temperature adjustment



3000K (±300K)

4000K (±300K)

6000K (±300K)

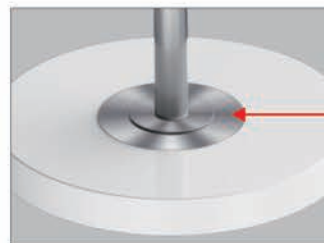

Decorative with brushed panel

BI-1928-C



Multi-functional LED Floor lamp

Multi-functional LED Floor lamp LCD display of time, calendar, temperature/
Double luminaire/ Three CCT/ Stepless dimming/ Wireless charging/ Supporting tray



BI-1928-C

Power: 15W LED (included)
Voltage: AC100-240V, DC13.5V
Colour Temp: 3000K-4000K-6000K



White



Grey



Supporting tray with wireless charging

Black

Portected by patent,if initated will be investigated
Design patent certificate number : 202130596863.0
202130597222.7

Multi-functional LED Floor lamp LCD display of time, calendar, temperature/
Double luminaire/ Three CCT/ Stepless dimming/ Wireless charging/ Supporting tray

BI-1928-C

Up lighting

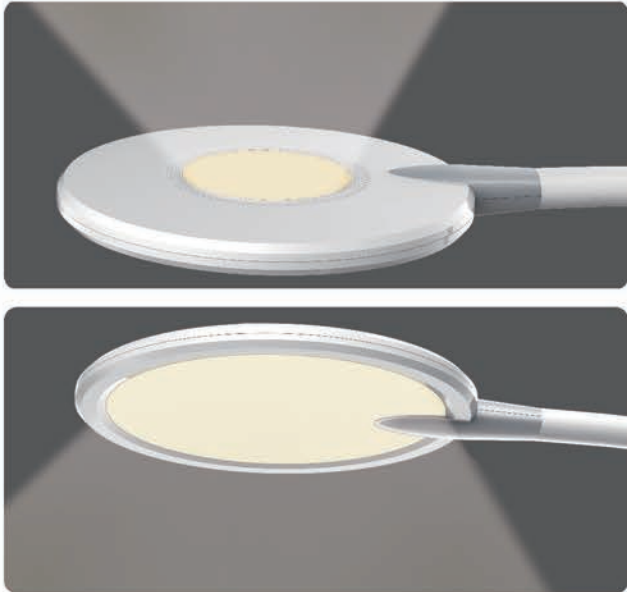

Down lighting

(First step: Long press ON/OFF to switch Red/Blue indicator light)

- Blue indicator light on, control LCD display function
- Red indicator light on, control main lamp

Blue indicator light on

- Slight press: Increase time /data
- Long press: Switch 12/24 hour style

Red indicator light on

- Adjust color temperature of main lamp
- 4000K-3000K-6000K(70% brightness in initial status)

Blue indicator light on

- Switch time/date
- When the digit flashing, press "▲" "▼" to adjust data (Switching sequence: Hour-Minute-Year-Month-Date)

Red indicator light on

- Slight press: Adjust brightness for main lamp in four steps(100%-50%-25%-10%)
- Long press: Stepless adjust brightness for main lamp(100%-10%)



Blue indicator light on

- Long press to switch temperature in Celsius/Fahrenheit
- When the digit flashing, press "▲" "▼" to adjust data

Red indicator light on

- Short press: On/Off for Up lighting
- Long press: Stepless dimming for Up light

First step: Long press ON/OFF to switch Red/Blue indicator light

- Blue indicator light on, control LCD display function

Red indicator light on, control main lamp
(Slight press to turn on/off main lamp when red indicator light on)



silicone hose design 360° rotating



Brushed aluminum lamppost

Three color temperature adjustment

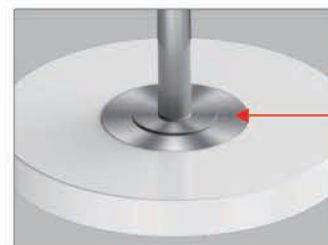
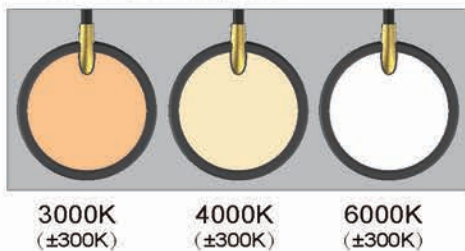

Decorative with brushed panel

Subject to the color in production at that time, if the colour of product above has been changed.

Three color temperature · Side panel lighting · Double dimming function · Rest reminder for reading · Off delay function

BL-1513

Power: 10W
Voltage: AC100-240V, DC12V
Colour Temp: 3000K-4000K-6500K (±300K)
Lumen: 530 Max
CRI: ≥90a



White

Blue

Pink

Protected by patent, if imitated will be investigated
Design patent certificate number: 202230449798.3

Subject to the color in production at that time, if the colour of product above has been changed.

Three color temperature · Side panel lighting · Double dimming function · Rest reminder for reading · Off delay function

BL-1513

LED Illuminated touch buttons

Rest reminder for reading

- ▲ Short press to set rest reminder, works in 30 mins
- ▲ Long press to test reminder function, lamp will flash in 5 seconds.

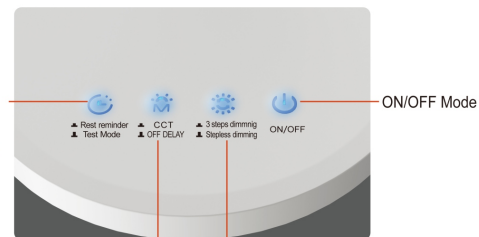

- ▲ Short press to adjust CCT
- ▲ Long press for off delay function.
- ▲ Short press for 3 steps dimming
- ▲ Long press for stepless dimming

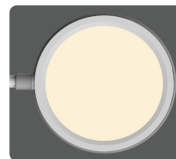

Side panel lighting, Soft light, Anti glare

90a Color rendering index, present the object's true color

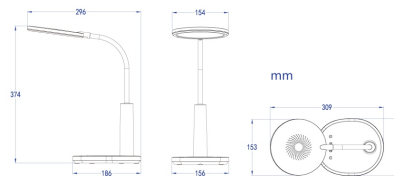

Size: 190*160*300mm
(6PCS): 500*395*320mm

Subject to the color in production at that time, if the colour of product above has been changed.

Three color temperature · Side panel lighting · Double dimming function · Rest reminder for reading · With LED night light

BL-1613

Power: 10W
Voltage: AC100-240V, DC12V
Colour Temp: 3000K-4000K-6500K (±300K)
Lumen: 530 Max
CRI: ≥90a



Blue

Pink

White

Patented by patent, if initiated will be investigated
Design patent certificate number: 202230449817.2

Three color temperature · Side panel lighting · Double dimming function · Rest reminder for reading · With LED night light

BL-1613

LED Illuminated touch buttons

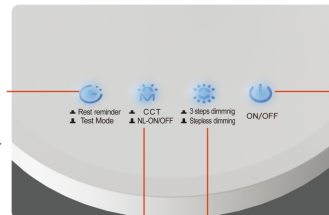

Rest reminder for reading

- ▲ Short press to set rest reminder, works in 30 mins
- ▮ Long press to test reminder function, lamp will flash in 5 seconds.

- ▮ Short press to adjust CCT
- ▮ Short press for 3 steps dimming
- ▮ Long press to turn on/off night light
- ▮ Long press for stepless dimming

ON/OFF Mode



With LED night light

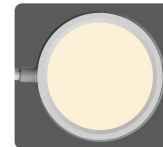

Side panel lighting, Soft light, Anti glare

90a Color rendering index, present the object's true color

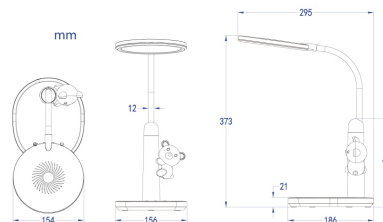

Size: 190*160*300mm
(6PCS): 500*395*320mm

Subject to the color in production at that time, if the colour of product above has been changed.

Subject to the color in production at that time, if the colour of product above has been changed.

Three color temperature · Side panel lighting · Double dimming function · Rest reminder for reading · With pen & phone holder · With LED night light

Power: 10W
Voltage: AC100-240V, DC12V
Colour Temp: 3000K-4000K-6500K (±300K)
Lumen: 530 Max
CRI: ≥90a

BL-1503



Blue

Pink

White

Protected by patent, if imitated will be investigated
Design patent certificate number: 202230449800.7

Three color temperature · Side panel lighting · Double dimming function · Rest reminder for reading · With pen & phone holder · With LED night light

BL-1503

LED Illuminated touch buttons

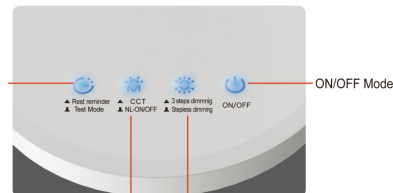

Rest reminder for reading

- ▲ Short press to set rest reminder, works in 30 mins
- ▲ Long press to test reminder function, lamp will flash in 5 seconds.

- ▲ Short press to adjust CCT
- ▲ Short press for 3 steps dimming
- ▲ Long press to turn on/off night light
- ▲ Long press for stepless dimming

pen holder

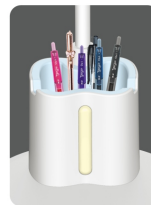

phone holder

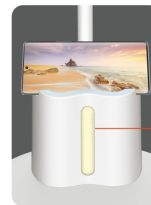

With night light

Side panel lighting, **Soft light**, Anti glare



90a Color rendering index, present the object's true color

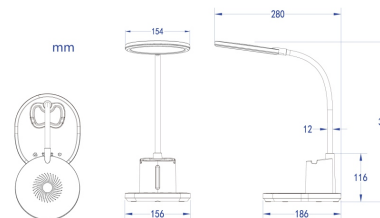

Size: 190*160*310mm
(6PCS): 500*395*330mm

Three color temperature · Double dimming function ·
Rest reminder for reading · Off delay function

BL-1515

Power: 8W
Voltage: AC100-240V, DC12V
Colour Temp: 3000K-4000K-6500K (±300K)
Lumen: 500 Max
CRI: ≥80a



White



Blue



Pink

Three color temperature · Double dimming function ·
Rest reminder for reading · Off delay function

BL-1515

LED Illuminated touch buttons

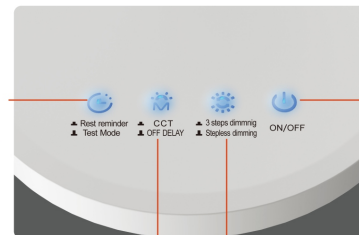

Rest reminder for reading

- ▲ Short press to set rest reminder, works in 30 mins
- Long press to test reminder function, lamp will flash in 5 seconds.

- ▲ Short press to adjust CCT
- Long press for off delay function.
- ▲ Short press for 3 steps dimming
- Long press for stepless dimming

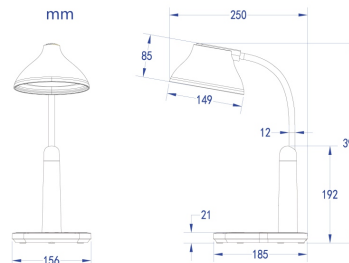

Size: 190*160*300mm
(6PCS): 500*395*320mm

Protected by patents/initial will be investigated
Design patent certificate number: Z02230449821.9

Subject to the color in production at that time, if the color of product above has been changed.

Three color temperature · Double dimming function ·
Rest reminder for reading · With LED night light

BL-1615

Power: 8W
Voltage: AC100-240V, DC12V
Colour Temp: 3000K-4000K-6500K (±300K)
Lumen: 500 Max
CRI: ≥80a



White

Patented by patent/initial will be investigated
Design patent number: 202230449796.4

Three color temperature · Double dimming function ·
Rest reminder for reading · With LED night light

BL-1615

LED Illuminated touch buttons

Rest reminder for reading

- ▲ Short press to set rest reminder, works in 30 mins
- Long press to test reminder function, lamp will flash in 5 seconds.

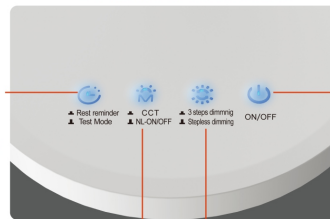

- ▲ Short press to adjust CCT
- Long press to turn on/off night light
- ▲ Short press for 3 steps dimming
- Long press for stepless dimming



With LED night light

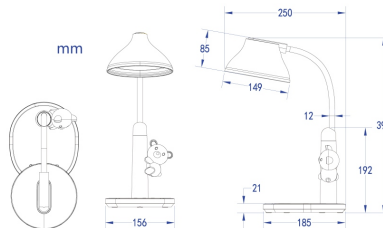

Size: 190*160*300mm
(6PCS): 500*395*320mm

Three color temperature · Double dimming function · Rest reminder for reading ·
With pen & phone holder · With LED night light

Power: 8W
Voltage: AC100-240V, DC12V
Colour Temp: 3000K-4000K-6500K (±300K)
Lumen: 500 Max
CRI: ≥80a

BL-1505



Blue



Pink



White

Patented by patent/initial will be investigated
Design patent number: 202230449823.8

Three color temperature · Double dimming function · Rest reminder for reading ·
With pen & phone holder · With LED night light

BL-1505

LED Illuminated touch buttons

Rest reminder for reading

- ▲ Short press to set rest reminder, works in 30 mins
- ▲ Long press to test reminder function, lamp will flash in 5 seconds.

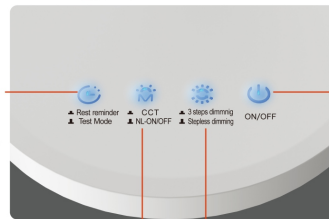

- ▲ Short press to adjust CCT
- ▲ Long press to turn on/off night light
- ▲ Short press for 3 steps dimming
- ▲ Long press for stepless dimming

pen holder



phone holder

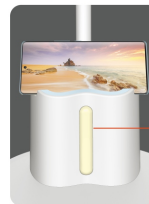

With night light

mm

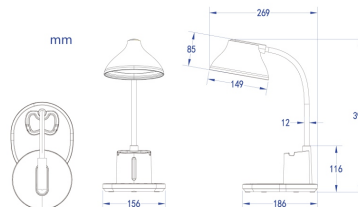

Size: 190*160*310mm
(6PCS): 500*395*330mm

Three color temperature · Double dimming function ·
Rest reminder for reading · With LED night light

Power: 8W
Voltage: AC100-240V, DC12V
Colour Temp: 3000K-4000K-6500K (±300K)
Lumen: 500 Max
CRI: ≥80a

BL-1616



White



Blue



Pink

Three color temperature · Double dimming function ·
Rest reminder for reading · With LED night light

BL-1616

LED Illuminated touch buttons

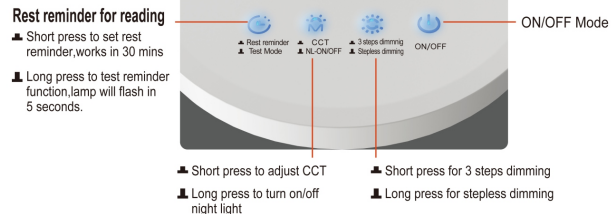

With LED night light

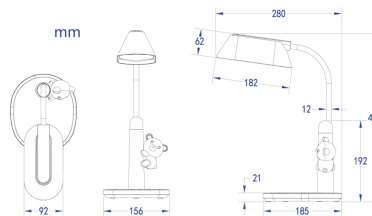

Size: 190*160*300mm
(6PCS): 500*395*320mm

Three color temperature · Double dimming function · Rest reminder for reading ·
With pen & phone holder · With LED night light

BL-1525

Power: 8W
Voltage: AC100-240V, DC12V
Colour Temp: 3000K-4000K-6500K (±300K)
Lumen: 500 Max
CRI: ≥80a



Three color temperature · Double dimming function · Rest reminder for reading ·
With pen & phone holder · With LED night light

BL-1525

LED Illuminated touch buttons

Rest reminder for reading

- ▲ Short press to set rest reminder, works in 30 mins
- ▲ Long press to test reminder function, lamp will flash in 5 seconds.

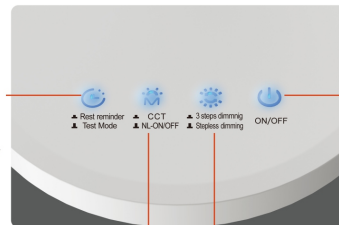

- ▲ Short press to adjust CCT
- ▲ Long press to turn on/off night light
- ▲ Short press for 3 steps dimming
- ▲ Long press for stepless dimming

pen holder



phone holder

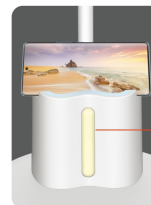

With night light



Size: 190*160*310mm
(6PCS): 500*395*330mm

mm

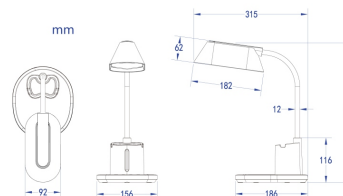



Three color temperature · Side panel lighting
Sliding stepless dimming

BL-1121

Power: 10W
Voltage: AC100-240V, DC12V
Colour Temp: 3000K-4000K-6500K (±300K)
Lumen: 650 Max
CRI: >80a



Brushed Silver

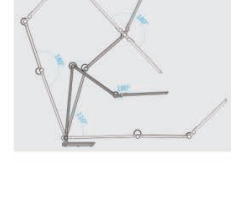
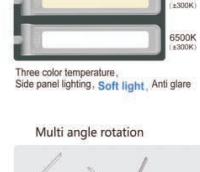

Metallic Grey

Powered by patent/ issued will be investigated
Registration number: 202230229664



BL-1131

Three color temperature · Side panel lighting
Touch stepless dimming · Delayed light off function

BL-1131

Power: 10W
Voltage: AC100-240V, DC12V
Colour Temp: 3000K-4000K-6500K (±300K)
Lumen: 550 Max
CRI: >90a

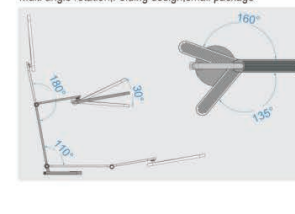
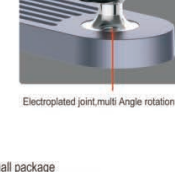
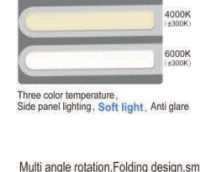
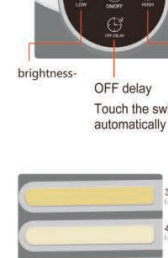

Metallic Grey



Matt White



Matt Black

Powered by patent/ issued will be investigated
Registration number: 202230229664



BL-1131-C

Wireless charging · Three color temperature · Side panel lighting
Touch stepless dimming · Delayed light off function

BI-1131-C

Power: 10W
Voltage: AC100-240V, DC13.5V
Colour Temp: 3000K-4000K-6500K (±300K)
Lumen: 550 Max
CRI: >90a

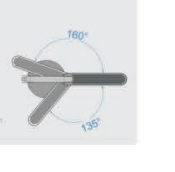
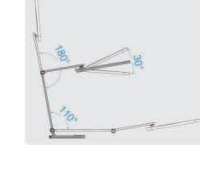
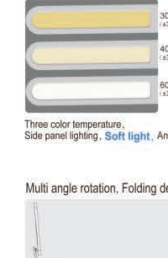

Metallic Grey



Matt White



Matt Black

Powered by patent/ issued will be investigated
Registration number: 202230229664



BL-1235

LCD display of time · Rest reminder for reading · Three color temperature,
Three steps dimming · Side panel lighting, anti glare soft light.

BL-1235

Power: 10W
Voltage: AC100-240V, DC12V
Colour Temp: 3000K-4000K-6500K (±300K)
Lumen: 600 Max
CRI: >90a

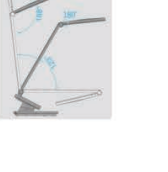

White



Metallic Grey



Black

Powered by patent/ issued will be investigated
Registration number: 202230229664



Sliding stepless dimming · Rainbow LED indicator
Rest reminder for reading · Side panel lighting

BL-1237

Power: 10W
Voltage: AC100-240V, DC12V
Colour Temp: 4000K (±300K)
Lumen: 600 Max
CRI: >90a



White



Black



Blue

Powered by patent/ issued will be investigated
Registration number: 202230229664



Three color temperature · Side panel lighting · Rotating stepless dimming · Delayed light off function

BL-1268

Power: 10W
Voltage: AC100-240V, DC12V
Colour Temp: 3000K-4000K-6500K (±300K)
Lumen: 550 Max
CRI: >90a

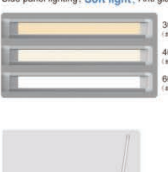

Silver



Metallic Grey

Powered by patent/ issued will be investigated
Registration number: 202230229664



Wireless charging · Three color temperature · Side panel lighting · Rotating stepless dimming · Delayed light off function

BL-1268-C

Power: 10W
Voltage: AC100-240V, DC13.5V
Colour Temp: 3000K-4000K-6500K (±300K)
Lumen: 550 Max
CRI: >90a

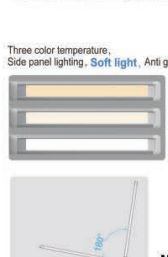

Silver



Metallic Grey

Powered by patent/ issued will be investigated
Registration number: 202230229664



Side panel lighting · Sliding stepless dimming · Delayed light off function

BL-1296

Power: 9W
Voltage: AC100-240V, DC12V
Colour Temp: 4000K (±300K)
Lumen: 550 Max
CRI: >90a

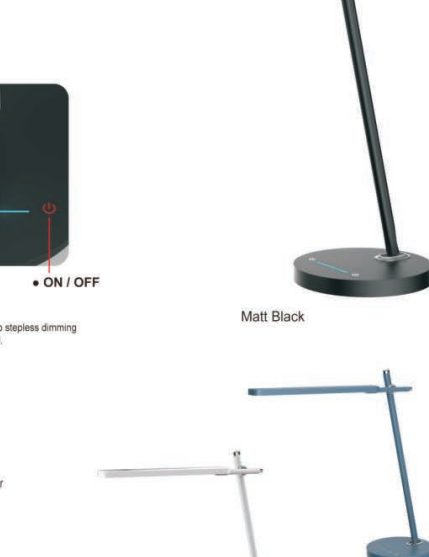
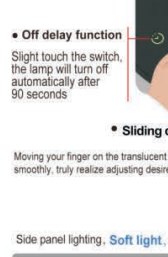

Matt Black



Metallic Grey

Powered by patent/ issued will be investigated
Registration number: 202230229664