

2021-2022



About nelux

After 15 years working in european lighting market, we decide to settle down our head office in Hong Kong in 2010. Since 1995 in the custom made light fixtures in Europe and since 2010 working as lighting product designers.

We have two lines of work:

Management mould manufacturing
Nelux design and produce the product you need .Design and consultancy department specialized in custom manufacturing tooling machining lighting products for your lighting projects , designing your own light fixtures for your own projects. From Nelux we put our knowledge at your service for the execution of all processes from the design and creation of a lighting product to its production

Our products

Nelux Architectural lighting product designers company, offer a huge range of products specifically for architectural lighting applications and high-end lighting projects. The main benefits of our products are low power consumption and high reliability . Our LED lighting products utilize only the best and most current components.



Mould department

Our mould management lighting product department is an independent lighting design consultancy working across a wide range of products for our clients projects; we produce and advice our clients in the type of products useful for their projects from hotels, restaurants, and retail spaces to landscape and residential lighting design.

Our team of professional lighting products designers have over 25 years experience in the lighting industry with an established reputation. First and foremost we listen to our clients and work with you every step of the way; developing a custom lighting plan and implementing it into your space. We know our field inside out bringing professional input and experience to ensure your projects will have the accurate products without any hitches.

Design department

To design your own lighting fixtures for your lighting project we have in our company the design thinking and exploring the environment for creative problem-solving. Whether our clients are designing a new product or modifying and reinventing an old product to update it, or we design your own light fixtures we are here to add our little grain of sand. To create and produce with success a new product in the lighting market, we think innovation, simplicity, functionality, high quality and a competitive price are the main issues. We could develop each of these points but it is not our goal at this moment, here we intend to tell our customers the cost of each phase. Design your own lighting fixtures by our team can take a cost depending of complexity of pieces. The complexity in the development of the idea that our client provides is what determines its cost. Always indicating the time dedicated to it and the team responsible for the project. The cost of design a lighting product for your lighting project does not include the cost of tooling-molds and unit-production cost. All these prices are only indicative because each project is different according to customer needs.

Mold cost

Cost to produce a lighting product mold for your lighting is decisive for the decision to make.

The mold cost to create a small piece of aluminum such as a recessed downlight can range among different prices depending on project size. Injecting the pieces has a cost per unit depending on thickness, aluminum quality, and complexity. This cost only includes what is the core of the piece, all the different accessories will imply an increase in the cost of the product plus the LED brand, the driver brand, the assembly, the packaging and labeling. All these prices are only indicative because each project is different according to customer needs.

If you need a budget for any idea you have, please contact us.

Sections

Waterproof downlight	pages from 7-12
Fire rated down light	pages from 13
Spot light	pages from 14-24
Down light	pages from 25-38
Surface ceiling light	pages from 39-46
Remote control light	pages from 47-50
Track head light	pages from 51-67
Down & track head light	pages from 68-71
Inline light	pages from 72-81
Pendant light	pages from 82-86
Cardan-Multiple light	pages from 87-88
Profile light	pages from 89-92

WATER PROOF DOWN LIGHT

Upgrade your projects as bathrooms, gymnasium, wellness areas, spa, terraces for the chance to enjoy new design with nelux waterproof downlight and fire rated products giving a chic touch.



A bathroom is split up into three different zones. The zonal requirements of each area are mainly dependent upon the risk level of water getting close to or touching the electrical supply. This would cause damage to the installation but more importantly poses a risk of electric shock. The three bathroom zones are:

Zone 0

This zone requires a minimum of IP68. This is the area within a bath tub or shower. Only 12V SELV (Safety Extra Low Voltage) equipment can be used.

Zone 1

Requires a minimum of IP44. This is the area directly above a bath and within a shower cubicle up to 2.25M in height.

Zone 2

Same as above, requires a minimum of IP44. This is the area outside of the bathroom and shower zone.

For areas outside of these zones (formally known as zone 3), normal rules apply and no IP rating is required.

Un baño se divide en tres zonas diferentes. Los requisitos principales dependen principalmente del nivel de riesgo de que el agua pueda llegar al suministro eléctrico o los empotrables. Esto causaría daños a la instalación pero, lo que es más importante, presenta un riesgo de descarga eléctrica.

Las tres zonas de baño son:

Zona 0

Esta zona requiere un mínimo de IP68. Esta es el área dentro de una bañera o ducha. Solo se pueden utilizar equipos de 12V SELV (Safety Extra Low Voltage).

Zona 1

Requiere un mínimo de IP44. Esta es el área directamente encima de una bañera y dentro de una cabina de ducha, hasta 2,25 m de altura.

Zona 2

Igual que el anterior, requiere un mínimo de IP44. Ésta es el área fuera del baño y la zona de ducha.

Para áreas fuera de estas zonas (formalmente conocidas como zona 3), se aplican las reglas normales y no se requiere clasificación IP.

nelux architectural lighting



Waterproof downlight

In nelux we advise you about waterproof downlight for damp areas, as bathrooms, gym, wellness areas, spa, terrace, patio our downlights prevent moisture from entering the light body. All our series create a relaxed ambiance or bright functional lighting, depending on your specific requirements for your lighting projects.

All of our waterproof led downlights to have a rating of ip44 or above ensuring they are sealed and fully water-resistant being the perfect option for humidity specific areas detailed above.

Waterproof and fire rated downlights

TEGALOUT series



FIRENZE series



DAMP series



FLAM fire rated series



Fire rated downlight

In any building where people maybe living or inhabiting above, the ceiling below should be fire rated depending on Building regulations of your country. Fire rated downlights are used to restore the fire integrity of a ceiling.

In the event of a fire fire rated downlights seal off the hole and slow down the spread of fire. Modern fire rated downlights are fitted with an intumescent pad which swells up when it reaches a certain temperature and blocks the spread of fire. The fire then has to find another way around - delaying its progress. This delay allows occupants to escape the building or ideally allows additional time for the fire to be extinguished. You will notice that some fire rated downlights are rated at 30, 60 or 90 minutes. This rating depends on the structure of the building and more importantly how many floors it has. The top floor of a block of flats for example would require a 90 or possibly 120 minute fire rating, whilst a ceiling in the bottom floor of a house would be 30 or 60 minutes.

Please remember, you must follow the strict electrical safety regulations of your country and pay attention to IP ratings.







TEGAL OUT



Product description

Materials used , aluminum die casting make these series suitable for your damping indoor lighting projects, as terraces, bathroom, spa, gymnasium, wellness areas. Led colour temperature 2700K, 3000K & 4000K as standards. Can be used with or without honey-comb.

Accessories & options

-  Cree, citizen
-  Dimmable (Triac, 0-10v)
-  CRI>90 or above
-  DALI
-  Khün, osram



Tegal out series

SL9049.08 Ip65 Cree/Citizen led



SL9049.08 - Input voltage AC220-240V Multivoltage
8W
~900lm - 2700K-3000K-4000K
CRI>80
led cob Cree

SL9077.08 Ip65 Cree/Citizen led

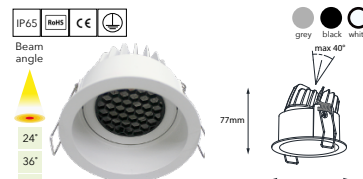

SL9077.08 - Input voltage AC220-240V Multivoltage
8W
~900lm - 2700K-3000K-4000K
CRI>80
led cob Cree

SL9090D.08 Ip65 Cree/Citizen led

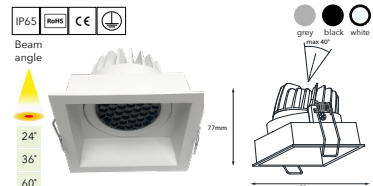

SL9090D.08 - Input voltage AC220-240V Multivoltage
8W
~900lm - 2700K-3000K-4000K
CRI>80
led cob Cree

SL9090.08 Ip65 Cree/Citizen led

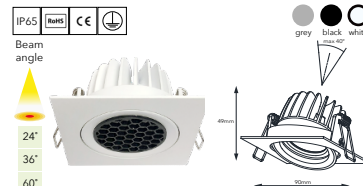

SL9090.08 - Input voltage AC220-240V Multivoltage
8W
~900lm - 2700K-3000K-4000K
CRI>80
led cob Cree

Application ideas

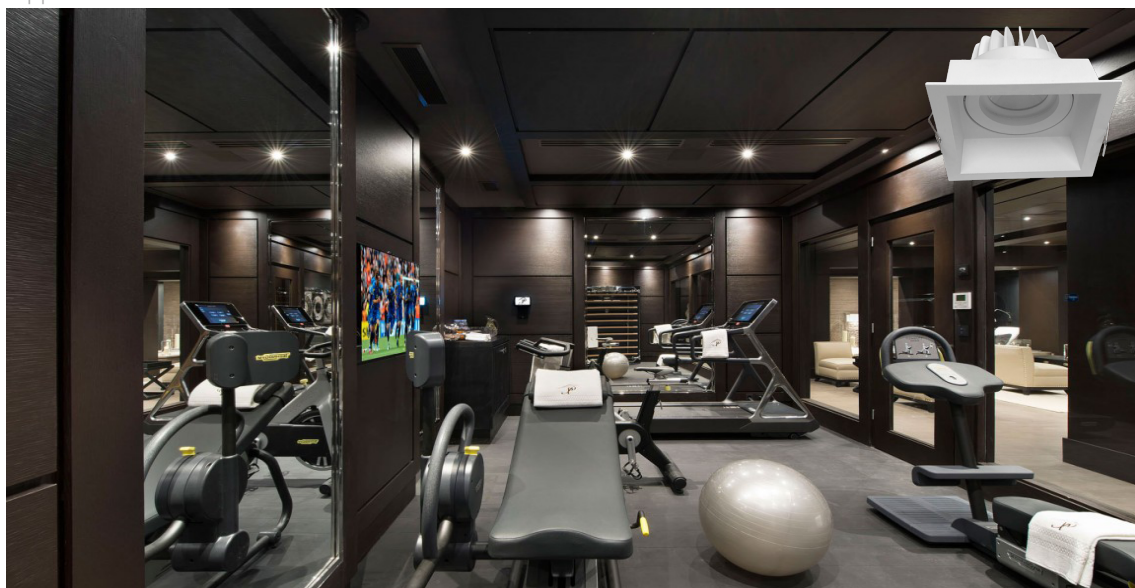

Waterproof downlight

Waterproof downlight



FIRENZE



Product description

FIRENZE series made from aluminum, electrostatic powder coating. Inter changeable inner rings as an option, adjustable and fix downlight . Available power 5W, 8W and 10W Firenze series suitable for bathroom, gymnasium, dump areas, spa, wellness areas, hotels, restaurants. Led colour temperature 2700K, 3000K & 4000K as standards. , different angles available. Led drivers khün, osram, philips.Ip54 and Ip65

Accessories & options

- Epistar, citizen
- Dimmable (Triac, 0-10v)
- CRI>90 or above
- DALI
- Khün, osram,
- Dim to warm



Firenze series

SL8065.05 - 10

Beam angle

 65mm

 SL8065.05 - 10 - Input voltage AC220-240V Multi-voltage
 5W or 10W
 ~425lm - 850lm 2700K-3000K-4000K
 CRI>80
 led epistar
 Interchangeable inner rings

SL11076.10 - 15

Beam angle

 76mm

 SL11076.10 - 15 - Input voltage AC220-240V Multi-voltage
 10W or 15W
 ~850lm - 1275lm 2700K-3000K-4000K
 CRI>80
 led epistar

SL8065S.05 - 10

Beam angle

 76mm

 SL8065S.05 - 10 - Input voltage AC220-240V Multi-voltage
 5W or 10W
 ~425lm - 850lm 2700K-3000K-4000K
 CRI>80
 led cob epistar

SL10576.10 - 15

Beam angle

 76mm

 SL10576.10 - 15 - Input voltage AC220-240V Multi-voltage
 10W or 15W
 ~850lm - 1275lm 2700K-3000K-4000K
 CRI>80
 led cob epistar

SL7853.08

Beam angle

 53mm

 SL7853.08 - Input voltage AC220-240V Multivoltage
 8W
 ~710lm 2700K-3000K-4000K
 CRI>80
 led cob epistar

SL9852.08

Beam angle

 52mm

 SL9852.08 - Input voltage AC220-240V Multivoltage
 8W
 ~710lm 2700K-3000K-4000K
 CRI>80
 led cob epistar

Application ideas



Optional features

CCT Range

 5000K
 6000K

Changeable CCT

Dimmable brightness

Reflector or lens

Waterproof downlight

Waterproof downlight



DAMP



Product description

DAMP series with high quality LED chips. The light color is pure with excellent color consistency and high CRI . High quality reflector design, different body colors , Black, White and Grey. Embedded LED chip design for better glare control. Fix angle, to meet the lighting requirements for a damp area. and different beam angle available. Specially designed for Bathrooms, Wellness areas, Spa's, Hotels, Fitness center,...

Accessories & options

- Cree, citizen
- Dimmable (Triac, 0-10v)
- CRI>90 or above
- DALI
- Khün, osram, philips
- Dim to warm



Damp series

DL9898.08



DL9898.08 - Input voltage AC220-240V Multivoltage
8W
~730lm - 850lm 2700K-3000K-4000K
CRI>80
led cree

DL9898.14



DL9898.14 - Input voltage AC220-240V Multivoltage
14W
~1250lm - 1275lm 2700K-3000K-4000K
CRI>80
led cob cree

DL125120.20



DL125120.20 - Input voltage AC220-240V Multivoltage
20W
~1880lm - 850lm 2700K-3000K-4000K
CRI>80
led cob cree

DL125120.24



DL125120.24 - Input voltage AC220-240V Multivoltage
24W
~2200lm - 1275lm 2700K-3000K-4000K
CRI>80
led cob cree

DL150132.28



DL150132.28 - Input voltage AC220-240V MultiV
28W
~2400lm 2700K-3000K-4000K
CRI>80
led cob cree

DL150132.35



DL150132.35 - Input voltage AC220-240V MultiV
35W
~3300lm 2700K-3000K-4000K
CRI>80
led cob cree

Application ideas



Optional features

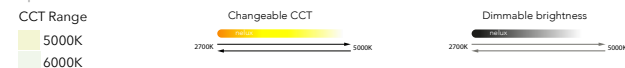

Waterproof downlight

Waterproof downlight



WELLNESS



Product description

Wellness series, made from aluminum die casting. Downlights suitable for your damp indoor lighting projects, as terraces, bathroom, spa, gymnasium, wellness areas. Led colour temperature 2700K, 3000K & 4000K as standards. Two models with lens or opal diffuser.

Accessories & options

- Epistar, citizen
- Dimmable (Triac, 0-10v)
- CRI > 90 or above
- DALI
- Khün, osram
- Dim to warm

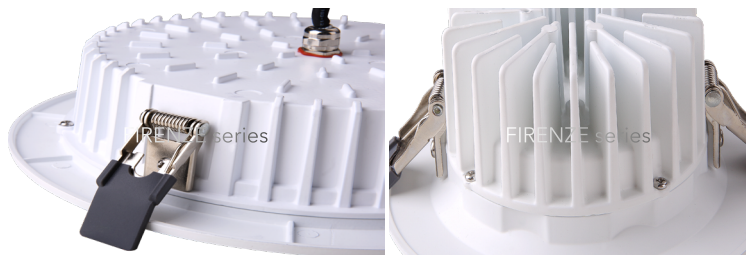

Firenze series

DW9550.10



DW9550.10 - Input voltage AC220-240V Multivoltage
10W
~890lm - 2700K-3000K-4000K
CRI>80
led cree

DW11555.15

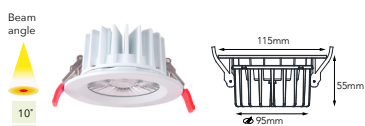

DW11555.15 - Input voltage AC220-240V Multivoltage
15W
~1140lm - 2700K-3000K-4000K
CRI>80
led cree

DW15567.20



DW15567.20 - Input voltage AC220-240V Multivoltage
20W
~1990lm - 2700K-3000K-4000K
CRI>80
led cob cree

DW9550SMD.10 Acrylic diffuser



DW9550SMD.10 - Input voltage AC220-240V Multivoltage
10W
~790lm 2700K-3000K-4000K
CRI>80
led smd samsung

DW11555SMD.15

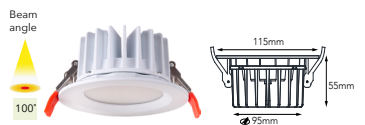

DW11555SMD.15 - Input voltage AC220-240V MultiV
15W
~890lm 2700K-3000K-4000K
CRI>80
led smd samsung

DW15567SMD.20



DW15567SMD.20 - Input voltage AC220-240V MultiV
20W
~1400lm 2700K-3000K-4000K
CRI>80
led smd samsung

DW119547SMD.25



DW119547SMD.25 - Input voltage AC220-240V Multi-voltage
25W
~1880lm 2700K-3000K-4000K
CRI>80
led smd samsung

DW23555SMD.30



DW23555SMD.30 - Input voltage AC220-240V Multi-voltage
30W
~2460lm 2700K-3000K-4000K
CRI>80
led smd samsung

Application ideas



Waterproof downlight

Waterproof downlight



FLAM



Product description

FLAM Die casting body, surface wrinkle treatment, effectively increasing the cooling area, good heat dissipation, let light remained in critical temperature to achieve a longer life. Flam series 30 60 90 min Fire Rated approval by SGS BS 476-21.IP65.100%.Three color change and Dim-to-warm available.Interchangeable bezel by twist & lock style, White, black,Chrome, polished chrome,brushed nickle surface treatment for option.. Size:Dia85*H56.5mm, Cut Out:72-75mm8. TUYA Bluetooth and WIFI, Wireless smart control. Special series suitable for Hotels, retail shops, coffe-shops, offices, museums, private houses, private clinics.

Accessories & options

- Cree, citizen
- Dimmable (Triac, 0-10v)
- CRI > 90 or above
- DALI
- Khün, osram,
- Dim to warm



Flam 6W-8W-9W-10W series

FR8557.08 IP65 & Fire rated

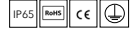

FR8557.08 - Input voltage AC220-240V Multivoltage
8W
~650lm 3000K-4000K-5000K
CRI>80
led citizen, bridgelux, cree, Khun

FR8557.10 IP65 & Fire rated



FR8557.10 - Input voltage AC220-240V Multivoltage
10W
~850lm 3000K-4000K-5000K
CRI>80
led citizen, bridgelux, cree, Khun

FR7580.06 IP65 & Fire rated



FR7580.06 - Input voltage AC220-240V Multivoltage
6W
~550lm 3000K-4000K-5000K
CRI>80
led citizen, bridgelux, cree, Khun

FR7580.08 IP65 & Fire rated



FR7580.08 - Input voltage AC220-240V Multivoltage
8W
~700lm 3000K-4000K-5000K
CRI>80
led citizen, bridgelux, cree, Khun

FR8251.09 IP65 & Fire rated



FR8251.09 - Input voltage AC220-240V Multivoltage
9W
~800lm 3000K-4000K-5000K
CRI>80
led citizen, bridgelux, cree, Khun

FR8550.06 IP65 & Fire rated



FR8550.06 - Input voltage AC220-240V Multivoltage
6W
~600lm 3000K-4000K-5000K
CRI>80
led citizen, bridgelux, cree, Khun

FR9050.06 IP65 & Fire rated



FR9050.06 - Input voltage AC220-240V Multivoltage
6W
~650lm 3000K-4000K-5000K
CRI>80
led 2835SMD

FR9050.08 IP65 & Fire rated



FR9050.08 - Input voltage AC220-240V Multivoltage
8W
~850lm 3000K-4000K-5000K
CRI>80
led 2835SMD

FR10053.10 IP65 & Fire rated



FR10053.10 - Input voltage AC220-240V Multivoltage
10W
~900lm 3000K-4000K-5000K
CRI>80
led citizen, bridgelux, cree, Khun

TUYA Bluetooth and WIFI, Wireless smart control



Optional features

CCT Range

- 5000K
- 6000K

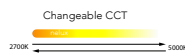

SPOT LIGHT

Upgrade your projects as hotels, retail shops, restaurants, private houses, private clinics for the chance to enjoy new design with nelux spotlight and fire rated products giving a chic touch.

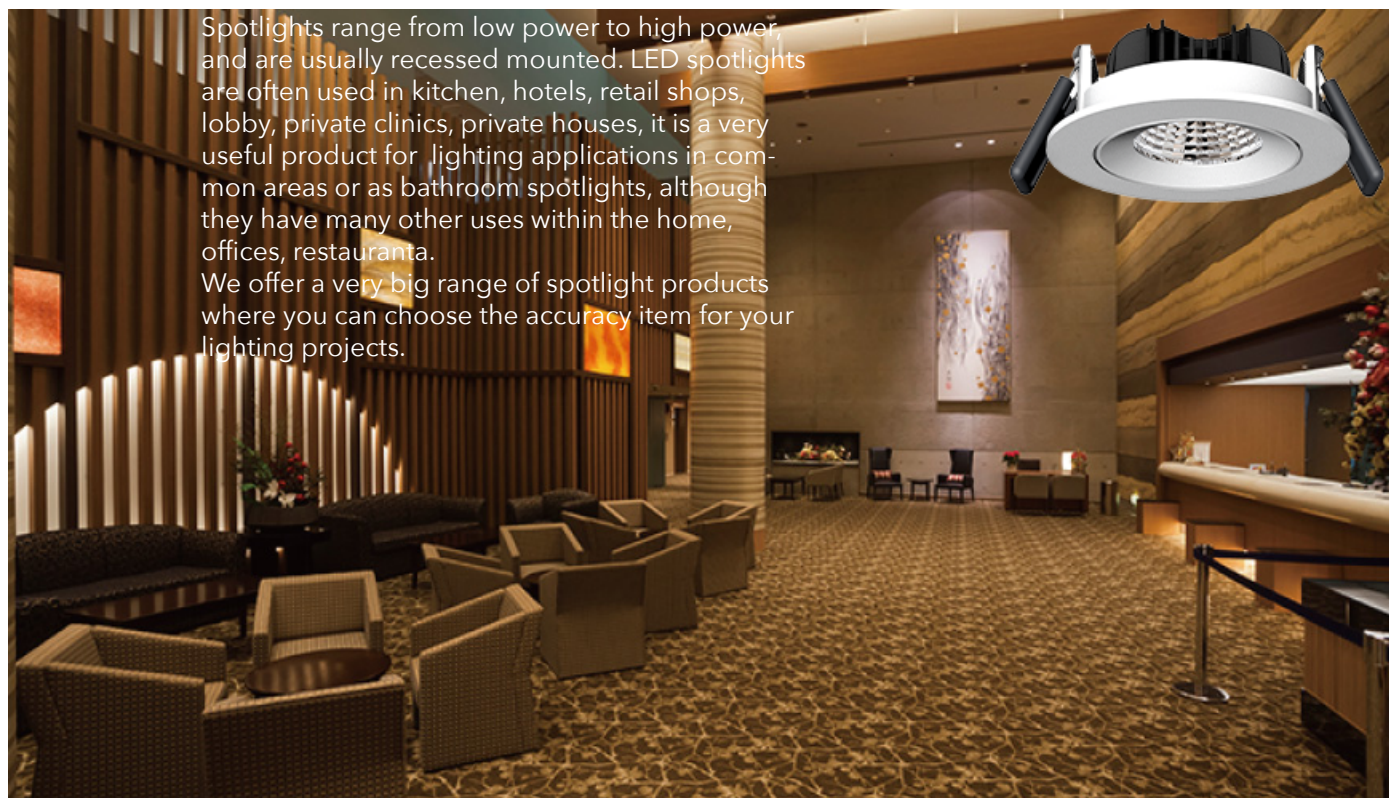

Spotlights range from low power to high power, and are usually recessed mounted. LED spotlights are often used in kitchen, hotels, retail shops, lobby, private clinics, private houses, it is a very useful product for lighting applications in common areas or as bathroom spotlights, although they have many other uses within the home, offices, restaurants.

We offer a very big range of spotlight products where you can choose the accuracy item for your lighting projects.

Disponemos de una gran variedad de focos desde pequeñas potencias hasta potencias elevadas , y por lo general se instalan en el techo. Los focos LED se suelen utilizar en cocinas, hoteles, comercios minoristas, vestíbulos, clínicas privadas, casas particulares, es un producto muy útil para aplicaciones de iluminación en áreas comunes o como focos de baño fuera de las zonas donde se recomienda Ip superiores al Ip44. Tienen muchos otros usos dentro del hogar, oficinas, restaurantes.

Ofrecemos una amplia gama de productos de focos donde puede elegir el elemento adecuado para sus proyectos de iluminación.

Spot lights

HOMI series 5W



HOMI series 8W



COMPAK series 5W-10W-18W



Spot light

In nelux we advise you about spotlights for private houses, hotel lobby, retail shops, commercial mall, public areas, terrace. All our series create a relaxed ambiance or bright functional lighting, depending on your specific requirements for your lighting projects.

All of our led spotlights to have a rating of ip44 , Ip65 and Ip20 ensuring they are sealed and fully water-resistant being the perfect option for humidity specific areas and Ip20 for indoor areas.

Please remember, you must follow the strict electrical safety regulations of your country and pay attention to IP ratings.

Spot lights

TITANI series 3W-5W-7W-9W



MUSH series 7W-12W-18W

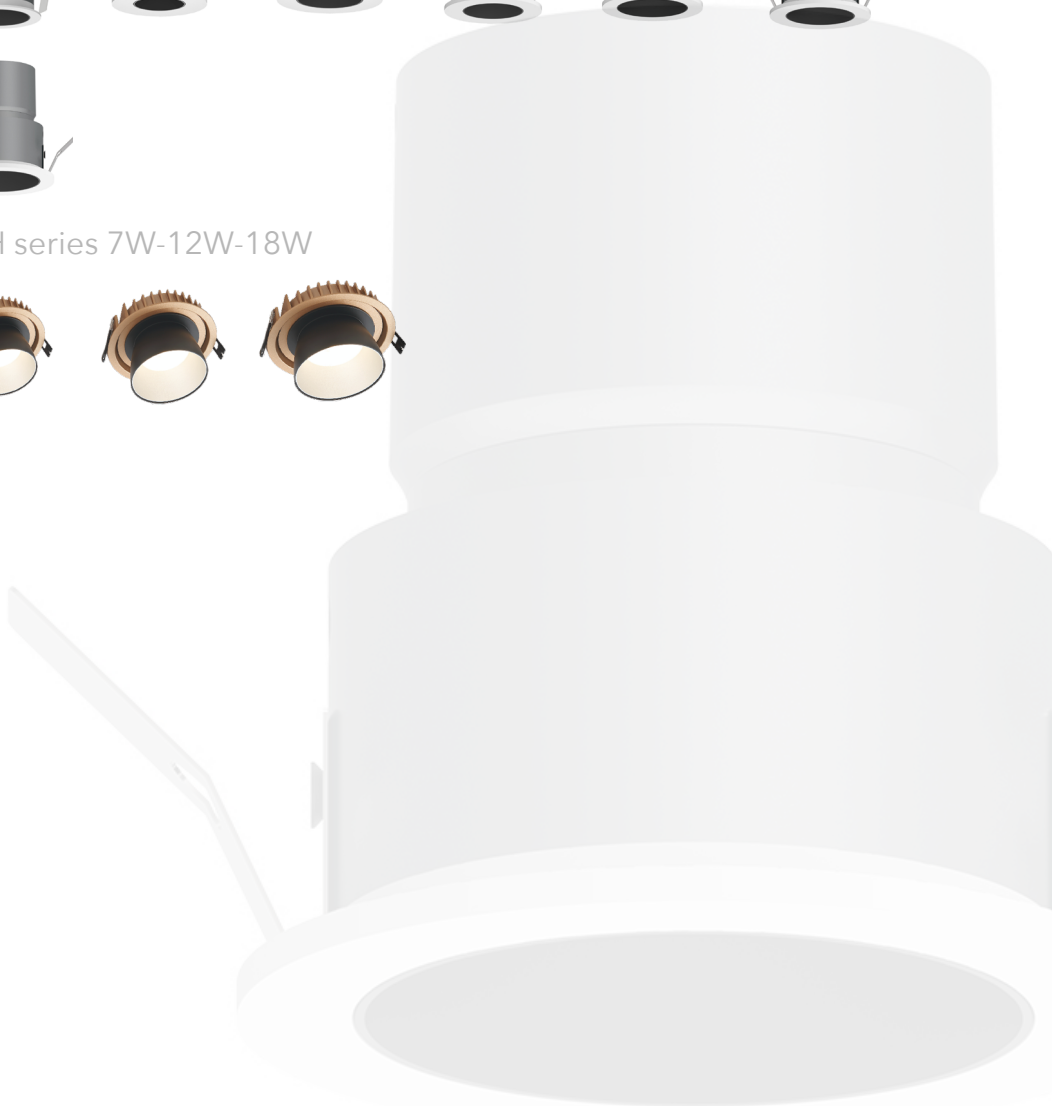

Spot light

In nelux we advise you about spotlights for private houses, hotel lobby, retail shops, commercial mall, public areas, terrace. All our series create a relaxed ambiance or bright functional lighting, depending on your specific requirements for your lighting projects.

All of our led spotlights have a rating of ip44, ip65 and ip20 ensuring they are sealed and fully water-resistant being the perfect option for humidity specific areas and ip20 for indoor areas.

Please remember, you must follow the strict electrical safety regulations of your country and pay attention to IP ratings.



HOMI



Product description

HOMI spot light series suitable for Hotels, retail shops, coffe-shops, offices, museums, private houses, private clinics. Led colour temperature 2700K, 3000K & 4000K as standards. Made from aluminum, electrostatic powder coating , reflectors made from PMMA, different angles available. Led drivers khün, osram, philips.

Accessories & options

- Luminus, Khün, cree
- Dimmable (Triac, 0-10v)
- CRI > 90 or above
- DALI
- Khün, osram,
- Dim to warm



Homi 5W series

<p>DL7036.05</p> <p>IP44 </p> <p>black white bright satin silver nickel</p> <p>Beam angle: 24°, 36°, 60°</p> <p>36mm</p> <p>Ø70mm Ø64mm</p> <p>DL7036.05 - Input voltage AC220-240V Multivoltage 120-135mA 36V, SDCM<3 5W ~410lm 2700K-3000K-4000K CRI>90 led cob cree</p>	<p>DL7036-1.05</p> <p>IP44 </p> <p>black white bright satin silver nickel</p> <p>Beam angle: 24°, 36°, 60°</p> <p>36mm</p> <p>Ø70mm Ø64mm</p> <p>DL7036-1.05 - Input voltage AC220-240V Multivoltage 120-135mA 36V, SDCM<3 5W ~410lm 2700K-3000K-4000K CRI>90 led cob cree</p>	<p>DL8035.05</p> <p>IP44 </p> <p>black white bright satin silver nickel</p> <p>Beam angle: 24°, 36°, 60°</p> <p>35mm</p> <p>Ø80mm Ø64mm</p> <p>DL8035.05 - Input voltage AC220-240V Multivoltage 120-135mA 36V, SDCM<3 5W ~410lm 2700K-3000K-4000K CRI>90 led cob cree</p>
<p>DL8035-1.05</p> <p>IP44 </p> <p>black white bright satin silver nickel</p> <p>Beam angle: 24°, 36°, 60°</p> <p>35mm</p> <p>Ø80mm Ø70mm</p> <p>DL8035-1.05 - Input voltage AC220-240V Multivoltage 120-135mA 36V, SDCM<3 5W ~410lm 2700K-3000K-4000K CRI>90 led cob cree</p>	<p>DL8035S- 5W</p> <p>IP44 </p> <p>black white bright satin silver nickel</p> <p>Beam angle: 24°, 36°, 60°</p> <p>35mm</p> <p>80x80mm Ø68mm</p> <p>DL8035S- Input voltage AC220-240V Multivoltage 120-135mA 36V, SDCM<3 5W ~410lm 2700K-3000K-4000K CRI>90 led cob cree</p>	<p>DL8035.1S - 5W</p> <p>IP44 </p> <p>black white bright satin silver nickel</p> <p>Beam angle: 24°, 36°, 60°</p> <p>35mm</p> <p>80x80mm Ø68mm</p> <p>DL8035.1S - Input voltage AC220-240V Multivoltage 120-135mA 36V, SDCM<3 5W ~410lm 2700K-3000K-4000K CRI>90 led cob cree</p>

Application ideas



Optional features

CCT Range

Changeable CCT: 2700K to 5000K (5000K, 6000K)

Dimmable brightness: 2700K to 5000K

Reflector or lens



HOMI



Product description

HOMI 5W spot light series suitable for Hotels, retail shops, coffe-shops, offices, museums, private houses, private clinics. Led colour temperature 2700K, 3000K & 4000K as standards. Made from aluminum, electrostatic powder coating, reflectors made from PMMA, different angles available. Led drivers khün, osram, philips.

Accessories & options

- Luminus, Khün, cree
- CRI>90 or above
- Khün, osram,
- Dimmable (Triac, 0-10v)
- DALI
- Dim to warm



Homi 5W series

DL7547.05



DL7547.05 - Input voltage AC220-240V Multivoltage
120-135mA 36V, SDCM<3
5W
~410lm 2700K-3000K-4000K
CRI>90
led cob cree

DL7046.05



DL7046.05 - Input voltage AC220-240V Multivoltage
120-135mA 36V, SDCM<3
5W
~410lm 2700K-3000K-4000K
CRI>90
led cob cree

DL7554.05



D7554.05 - Input voltage AC220-240V Multivoltage
120-135mA 36V, SDCM<3
5W
~410lm 2700K-3000K-4000K
CRI>90
led cob cree

DL7549.05



D7549.05 - Input voltage AC220-240V Multivoltage
120-135mA 36V, SDCM<3
5W
~410lm 2700K-3000K-4000K
CRI>90
led cob cree

Application ideas



Optional features

CCT Range

- 5000K
- 6000K

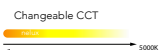

Reflector or lens

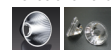



HOMI



Product description

HOMI 8W spot light series suitable for Hotels, retail shops, coffe-shops, offices, museums, private houses, private clinics. Led colour temperature 2700K, 3000K & 4000K as standards. Made from aluminum, electrostatic powder coating, reflectors or lens made from PMMA, different angles available. Led drivers khün, osram, philips.

Accessories & options

- Luminus, Khün, cree
- CRI>90 or above
- Khün, osram,
- Dimmable (Triac, 0-10v)
- DALI
- Dim to warm



Homi 8W series

DL9541.08 Fire rated

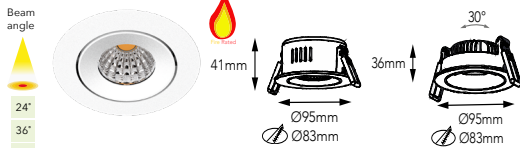
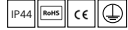

DL9541.08 fire rated & DL9536.08 - Input voltage AC220-240V Multivoltage
180mA 36V, SDCM<3
8W
~660lm 2700K-3000K-4000K
CRI>90
led cob cree

DL9541.01.08 Fire rated

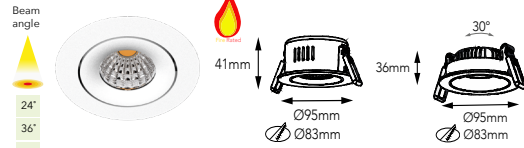

DL9541.01.08 fire rated & DL9536.01.08 - Input voltage AC220-240V Multi-voltage
180mA 36V, SDCM<3
8W
~660lm 2700K-3000K-4000K
CRI>90

DL8037.08



DL8037.08 - Input voltage AC220-240V Multivoltage
180mA 36V, SDCM<3
8W
~660lm 2700K-3000K-4000K
CRI>90
led cob cree

DL8035.08

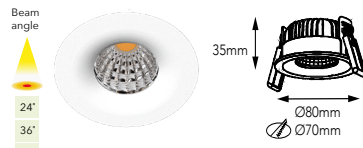

DL8035.08 - Input voltage AC220-240V Multivoltage
180mA 36V, SDCM<3
8W
~660lm 2700K-3000K-4000K
CRI>90
led cob cree

DL9536.08



DL9536.08 - Input voltage AC220-240V Multivoltage
120-135mA 36V, SDCM<3
8W
~660lm 2700K-3000K-4000K
CRI>90
led cob cree

DL9536.01.08



DL9536.01.08 - Input voltage AC220-240V Multi-voltage
120-135mA 36V, SDCM<3
8W
~660lm 2700K-3000K-4000K
CRI>90

DL9047.08



DL9047.08 - Input voltage AC220-240V Multivoltage
120-135mA 36V, SDCM<3
8W
~660lm 2700K-3000K-4000K
CRI>90
led cob cree

DL9062.08



DL9062.08 - Input voltage AC220-240V Multivoltage
120-135mA 36V, SDCM<3
8W
~660lm 2700K-3000K-4000K
CRI>90
led cob cree

DL9052.08



DL9052.08 - Input voltage AC220-240V Multivoltage
120-135mA 36V, SDCM<3
8W
~660lm 2700K-3000K-4000K
CRI>90
led cob cree

Optional features

CCT Range

- 5000K
- 6000K

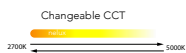

Dimmable brightness



Reflector or lens

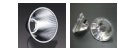



COMPAK



Product description

Compak series Made from aluminum, electrostatic powder coating and developed to combine the beauty and reliability into heat sink; Using high-quality LED chips, the light color is pure with excellent color consistency and high CRI. Precise optical design, with high light silver and black color as options, perfect light spot to create excellent lighting. External LED power supply, high power factor and high conversion efficiency. spot light series suitable for Hotels, retail shops, coffee-shops, offices, museums, private houses, private clinics.

Accessories & options

- Luminus, Khün, cree
- Dimmable (Triac, 0-10v)
- CRI > 90 or above
- DALI
- Khün, osram
- Dim to warm



Compak series

SL6450.06 Ip65 Cree



Beam angle

- 5°
- 24°
- 38°

SL6450.06 - Input voltage AC220-240V Multivoltage
5W
~432lm 2700K-3000K-4000K
CRI>80
led cob cree

black white

SL8570.10 Ip65 Cree



Beam angle

- 24°
- 30°
- 45°

SL8570.10 - Input voltage AC220-240V Multivoltage
10W
~750lm 2700K-3000K-4000K
CRI>80
led cob cree

black white

SL10585.18 Ip65 Cree



Beam angle

- 24°
- 36°
- 45°

SL10585.18 - Input voltage AC220-240V Multivoltage
18W
~1470lm 2700K-3000K-4000K
CRI>80
led cob cree

black white

Optional reflectors



Application ideas



Optional features

CCT Range

- 5000K
- 6000K

Changeable CCT

Dimmable brightness



TITANI



Product description

Titani series made from aluminum die-casting. Multiple beam angle. Integrated industrial design creating an amazing shape. External led power supply options to meet different lighting requirements. Embedded led chip to protect human eyes effectively. Professional reflector design. Spot light series suitable for Hotels, retail shops, coffee-shops, offices, museums, private houses, private clinics.

Accessories & options

- Khün, cree
- CRI>90 or above
- Khün, osram,
- Dimmable (Triac, 0-10v)
- DALI
- Dim to warm



Titani series 3W-5W

SL3843.03 Ip20 Cree



Beam angle

43mm

Ø 38mm
30mm

SL3843.03 - Input voltage AC220-240V Multivoltage
3W
~180lm 2700K-3000K-4000K
CRI>80
led cob cree

SL4564.03 Ip20 Cree



Beam angle

64mm

Ø 45mm
40mm

SL4564.03 - Input voltage AC220-240V Multivoltage
3W
~180lm 2700K-3000K-4000K
CRI>80
led cob cree

SL4556.03 Ip20 Cree



Beam angle

56mm

Ø 45mm
40mm

SL4556.03 - Input voltage AC220-240V Multivoltage
3W
~160lm 2700K-3000K-4000K
CRI>80
led cob cree

SL5781.05 Ip20 Cree



Beam angle

81mm

Ø 57mm
50mm

SL5781.05 - Input voltage AC220-240V Multivoltage
5W
~360lm 2700K-3000K-4000K
CRI>80
led cob cree

Application ideas



Optional features

CCT Range

- 5000K
- 6000K

Changeable CCT

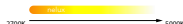

Dimmable brightness





TITANI



Product description

Titani series - made from aluminum die-casting. Multiple beam angle. Integrated industrial design creating an amazing shape. External led power supply options to meet different lighting requirements. Embedded led chip to protect human eyes effectively. Professional reflector design. Spot light series suitable for Hotels, retail shops, coffee-shops, offices, museums, private houses, private clinics.

Accessories & options

- Khün, cree
- CRI>90 or above
- Khün, osram,
- Dimmable (Triac, 0-10v)
- DALI
- Dim to warm



Titani series 7W - 9W

SL5771.07 Ip20 Cree



Beam angle

SL5771.07 - Input voltage AC220-240V Multivoltage
7W
~550lm 2700K-3000K-4000K
CRI>80
led cob cree

SL6892.07 Ip20 Cree



Beam angle

SL6892.07 - Input voltage AC220-240V Multivoltage
7W
~550lm 2700K-3000K-4000K
CRI>80
led cob cree

SL6884.09 Ip20 Cree



Beam angle

SL6884.09 - Input voltage AC220-240V Multivoltage
9W
~650lm 2700K-3000K-4000K
CRI>80
led cob cree

Application ideas



Optional features

CCT Range

Changeable CCT:

Dimmable brightness:



TITANI



Product description

Titani series made from aluminum die-casting. Multiple beam angle. Integrated industrial design creating an amazing shape. External led power supply options to meet different lighting requirements. Embedded led chip to protect human eyes effectively. Professional reflector design. Spot light series suitable for Hotels, retail shops, coffee-shops, offices, museums, private houses, private clinics.

Accessories & options

- Khün, cree
- Dimmable (Triac, 0-10v)
- CRI>90 or above
- DALI
- Khün, osram,
- Dim to warm



Titani series 3W-5W-7W

SL4246.03 Ip20 Cree

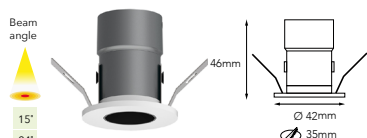

SL4246.03 - Input voltage AC220-240V Multivoltage
3W
~180lm 2700K-3000K-4000K
CRI>80
led cob cree

SL5245.03 adjustable Ip20 Cree

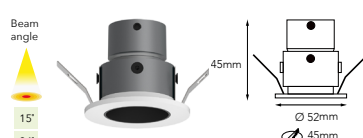

SL5245.03 - Input voltage AC220-240V Multivoltage
3W
~210lm 2700K-3000K-4000K
CRI>80
led cob cree

SL5663.05 Ip20 Cree

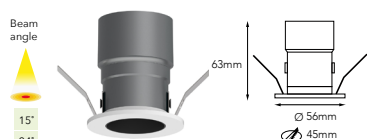

SL5663.05 - Input voltage AC220-240V Multivoltage
5W
~420lm 2700K-3000K-4000K
CRI>80
led cob cree

SL7070.05 adjustable Ip20 Cree

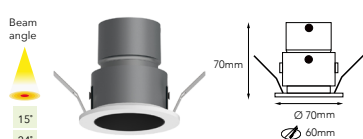

SL7070.05 - Input voltage AC220-240V Multivoltage
5W
~450lm 2700K-3000K-4000K
CRI>80
led cob cree

SL6271.07 Ip20 Cree

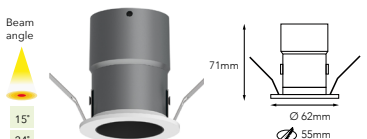

SL6271.07 - Input voltage AC220-240V Multivoltage
7W
~540lm 2700K-3000K-4000K
CRI>80
led cob cree

SL7580.07 adjustable Ip20 Cree

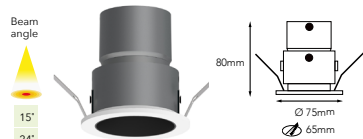

SL7580.07 - Input voltage AC220-240V Multivoltage
7W
~560lm 2700K-3000K-4000K
CRI>80
led cob cree

Optional features

CCT Range

- 5000K
- 6000K

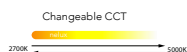

TITANI II

TITANI II

Spot light

Spot light



MUSH



Product description

Mush series - made from aluminum die-casting. Multiple beam angle. Integrated industrial design creating an amazing shape. External led power supply options to meet different lighting requirements. Embedded led chip to protect human eyes effectively. Professional reflector design. Spot light series suitable for Hotels, retail shops, coffee-shops, offices, museums, private houses, private clinics.

Accessories & options

- Khün, cree, citizen
- CRI>90 or above
- Khün, osram,
- Dimmable (Triac, 0-10v)
- DALI
- Dim to warm



Mush series 7W-12W-18W

SL8565.07 Ip20 Cree-Citizen



black&copper



SL8565.07 - Input voltage AC220-240V Multivoltage
7W
~500lm 2700K-3000K-4000K
CRI>90
led cob cree

SL11072.12 Ip20 Cree-Citizen SL11072 12W Ip20



black&copper



SL11072.12 - Input voltage AC220-240V Multivoltage
12W
~1000lm 2700K-3000K-4000K
CRI>90
led cob cree

SL13582.18 Ip20 Cree-Citizen



black&copper



SL13582.18 - Input voltage AC220-240V Multivoltage
18W
~1600lm 2700K-3000K-4000K
CRI>90
led cob cree



Optional features

CCT Range

- 5000K
- 6000K

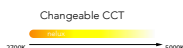

MUSH

MUSH

Spot light

Spot light

DOWN LIGHT

Upgrade your projects as restaurant, rooms, hotels , private clinics, offices, retail shops, for the chance to enjoy new design nelux downlight products giving a chic touch.



Downlight produce a beam of light that can be directed around the room or focused on certain areas thanks to their adjustable trims. Downlights can illuminate dark areas or forgotten corners to create a brighter space. They are often used in hotels, retail shops, restaurants, clinics, private houses, museums, universities, institutes to illuminate work spaces and surfaces. To light up general areas or your favourite area or a special feature with our wall washers.

Los Downlight, producen según modelos, un haz de luz general que ilumina una determinada área o bien focalizan la luz determinadas zonas gracias a sus embellecedores ajustables y/o ángulos determinados que nos permite resaltar los objetos deseados.

Los downlights pueden iluminar áreas oscuras o rincones olvidados para crear un espacio más brillante. Se utilizan a menudo en hoteles, tiendas minoristas, restaurantes, clínicas, casas particulares, museos, universidades, institutos para iluminar espacios y superficies de trabajo también para iluminar una amplia zona o su área favorita con nuestros bañadores de pared.

Down lights

DIAMOND series 10W-15W



AZEROX series 7W-12W-18W



LUCEN series 15W-20W-28W



CROT series 10W-15W



Down light

In nelux we advise you about our big range of downlights for private houses, hotel lobby, retail shops, commercial mall, public areas, terrace, corridors, private clinics. All our series create a relaxed ambiance or bright functional lighting depending on your specific requirements for your lighting projects.

All of our led downlights to have a rating of ip44 , lp65 and lp20 ensuring they are sealed and fully water-resistant being the perfect option for humidity specific areas and lp20 for indoor areas.

Please remember, you must follow the strict electrical safety regulations of your country and pay attention to IP ratings.

Down lights

CROT series 3W-5W-8W-12W-20W-25W



ZAIN series 7W-12W-20W

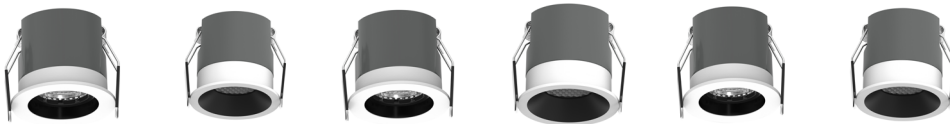

SILVEX series 8W



SILVEX series 6W-13W



SILVEX series 6W-13W special reflectors



Downlight

Downlight

Please remember, you must follow the strict electrical safety regulations of your country and pay attention to IP ratings.



DIAMOND



Product description

Diamond made from aluminium, frame changeable. Diamond golden cover series ,suitable for high end lighting projects ,suitable for Hotels, retail shops, coffe-shops, offices, museums, private houses, private clinics. Led colour temperature 2700K, 3000K & 4000K as standards. Two type fixed or adjustable. Multiple beam angles ,frame and frameless, fixed and adjustable as options, to meet different lighting requirements. Embedded LED chip design, cut-off angle more than 30°, to protect human eyes effectively.

Accessories & options

- Khün, cree, samsung
- Dimmable (Triac, 0-10v)
- CRI>90 or above
- DALI
- Khün, osram,
- Dim to warm



Diamond series -10W-15W

AG9269.10 Fixed

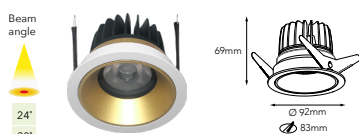

AG9269.10 - Input voltage AC220-240V Multivoltage 10W
~180lm 2700K-3000K-4000K
CRI>80
led samsung

AG8169.10 Fixed

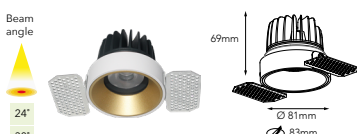
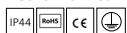

AG8169.10 - Input voltage AC220-240V Multivoltage 10W
~210lm 2700K-3000K-4000K
CRI>80
led samsung

AG9289.15 Fixed

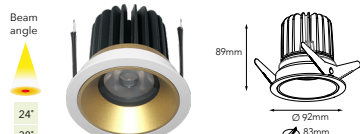

AG9289.15 - Input voltage AC220-240V Multivoltage 15W
~420lm 2700K-3000K-4000K
CRI>80
led samsung

AG8189.15 Fixed

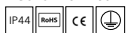

AG8189.15 - Input voltage AC220-240V Multivoltage 15W
~450lm 2700K-3000K-4000K
CRI>80
led samsung

AG10271.10 Adjustable

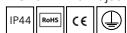

AG10271.10 - Input voltage AC220-240V Multiv 10W
~540lm 2700K-3000K-4000K
CRI>80
led samsung

AG8871.10 Adjustable

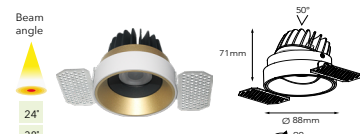

AG8871.10 - Input voltage AC220-240V Multivoltage 10W
~560lm 2700K-3000K-4000K
CRI>80
led samsung

AG10291.15 Adjustable



AG10291.15 - Input voltage AC220-240V Multivoltage 15W
~540lm 2700K-3000K-4000K
CRI>80
led samsung

AG8891.15 Adjustable

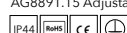

AG8891.15 - Input voltage AC220-240V Multivoltage 15W
~560lm 2700K-3000K-4000K
CRI>80
led samsung

Optional features

CCT Range

- 5000K
- 6000K

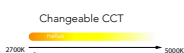

Two options: fixed or adjustable
Frame changeable
Honey comb
Optional reflectors: golden, chrome, silver, black



Downlight

Downlight



AZEROX



Product description

Azerox series made from aluminium, a variety of colors for decorative cover are available, suitable for a variety of decoration style and scene application. Multiple beam angles options, to meet different lighting requirements. Embedded LED chip design, cut-off angle more than 30°, to protect human eyes effectively. wall washer series suitable for Hotels, retail shops, coffee-shops, offices, museums, private houses, private clinics. Led colour temperature 2700K, 3000K & 4000K as standards. Adjustable model. Three kind of reflectors, round reflector, elliptical reflector and semi-circular

Accessories & options

- Khün, cree, samsung
- Dimmable (Triac, 0-10v)
- CRI>90 or above
- DALI
- Khün, osram,
- Dim to warm



Azerox series -8W-10W-20W-30W

WW84105.10 Adjustable Trimless



WW84105.10 - Input voltage AC220-240V Multivoltage
10W
~740lm 2700K-3000K-4000K
CRI>80
led cree cob

WW95105.10 Adjustable



WW95105.10 - Input voltage AC220-240V Multivoltage
10W
~740lm 2700K-3000K-4000K
CRI>80
led cree cob

WW8388.08 Adjustable



WW8388.08 - Input voltage AC220-240V Multivoltage
8W
~595lm 2700K-3000K-4000K
CRI>80
led cree cob

WW101126.20 Adjustable Trimless



WW101126.20 - Input voltage AC220-240V Multivoltage
20W
~1580lm 2700K-3000K-4000K
CRI>80
led cree cob

WW120126.20 Adjustable



WW120126.20 - Input voltage AC220-240V Multivoltage
20W
~1470lm 2700K-3000K-4000K
CRI>80
led cree cob

WW129152.30 Adjustable Trimless



WW129152.30 - Input voltage AC220-240V Multi
30W
~2180lm 2700K-3000K-4000K
CRI>80
led cree cob

WW148152.30 Adjustable

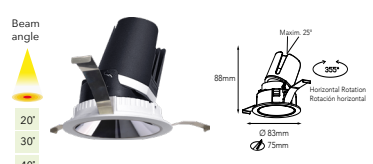

WW148152.30 - Input voltage AC220-240V Multivoltage
30W
~2210lm 2700K-3000K-4000K
CRI>80
led cree cob

Application ideas



Optional features

CCT Range

- 5000K
- 6000K

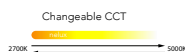

Dimmable brightness



Anti-glare accessories

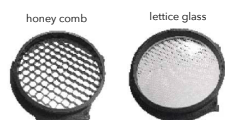

Optional reflectors round, elliptical, semi-circular





LUCEN



Product description

LUCEN series made from aluminium , suitable for a variety of decoration style and scene application. Multiple beam angles options, to meet different lighting requirements. Embedded LED chip design , to protect human eyes effectively. wall washer series suitable for villa club, exhibition hall, and other commercial space like Hotels, retail shops, coffe-shops, offices, museums, private houses, private clinics. **Special designed for your retail shops 15W, 20W, and 28W available**

Accessories & options

- Khün, cree, samsung
- Dimmable (Triac, 0-10v)
- CRI>90 or above
- DALI
- Khün, osram,
- Dim to warm



Lucen series 15W-20W-28W

DL15053.28

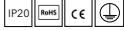

Beam angle
12°
24°
36°

53mm
30°
Ø150mm
Ø140mm

DL15053.28 - Input voltage AC220-240V Multivoltage 28W
~2875lm 2700K-3000K-4000K
CRI>80
led citizen cob

DL13053.20



Beam angle
15°
20°
36°

53mm
30°
Ø130mm
Ø120mm

DL13053.20 - Input voltage AC220-240V Multivoltage 20W
~2100lm 2700K-3000K-4000K
CRI>80
led citizen cob

DL11549.15



Beam angle
15°
24°
40°

49mm
30°
Ø115mm
Ø105mm

DL11549.15 - Input voltage AC220-240V Multivoltage 15W
~1650lm 2700K-3000K-4000K
CRI>80
led citizen cob

DL11196.28

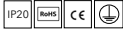

Beam angle
12°
24°
36°

96mm
45mm
Ø111mm

DL11196.28 - Input voltage AC220-240V Multivoltage 28W
~2945lm 2700K-3000K-4000K
CRI>80
led citizen cob

DL9389.20



Beam angle
15°
20°
36°
48°

89mm
38mm
Ø93mm

DL9389.20 - Input voltage AC220-240V Multivoltage 20W
~2310lm 2700K-3000K-4000K
CRI>80
led citizen cob

DL8085.15



Beam angle
12°
24°
36°
60°

85mm
33mm
Ø80mm

DL8085.15 - Input voltage AC220-240V Multivoltage 15W
~1650lm 2700K-3000K-4000K
CRI>80
led citizen cob

DL11155.28



Beam angle
12°
24°
36°

102.80mm
102mm
55.50mm
77.90mm
Ø115mm
Ø105mm

DL11155.28 - Input voltage AC220-240V Multivoltage 28W
~1650lm 2700K-3000K-4000K
CRI>80
led citizen cob

DL11295.28



Beam angle
12°
24°
36°

200mm
95mm
112mm
46.50mm
112mm

DL11295.28 - Input voltage AC220-240V Multivoltage 28W
~2900lm 2700K-3000K-4000K
CRI>80
led citizen cob

Optional features

CCT Range

- 5000K
- 6000K

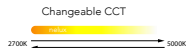

Dimmable brightness

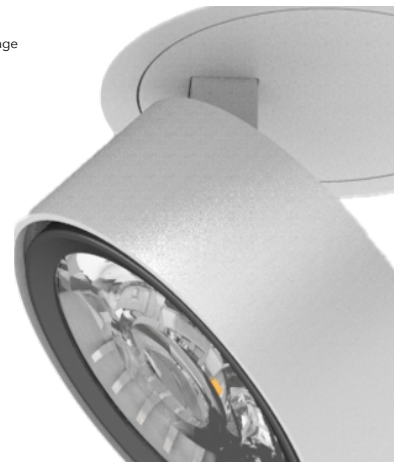

LUCEN

LUCEN

Downlight

Downlight



LUCEN



Product description

LUCEN series made from aluminium , suitable for a variety of decoration style and scene application. Multiple beam angles options, to meet different lighting requirements. Embedded LED chip design , to protect human eyes effectively. wall washer series suitable for villa club, exhibition hall, and other commercial space like Hotels, retail shops, coffe-shops, offices, museums, private houses, private clinics. **Special designed for your retail shops 20W and 28W available, special mounting system**

Accessories & options

- Khün, cree, samsung
- Dimmable (Triac, 0-10v)
- CRI>90 or above
- DALI
- Khün, osram,
- Dim to warm



Lucen series 20W-28W

DL9532.20



Beam angle

- 12°
- 24°
- 36°
- 48°
- 60°



DL9532.20 - Input voltage AC220-240V Multivoltage
20W
~2110lm 2700K-3000K-4000K
CRI>80
led citizen cob

DL11139.28



Beam angle

- 12°
- 24°
- 36°



DL11139.28 - Input voltage AC220-240V Multivoltage
28W
~2940lm 2700K-3000K-4000K
CRI>80
led citizen cob

Multiple Lucen cardan mounting system - Sistema de montaje

Two lamps mounting - Montaje dos lámparas

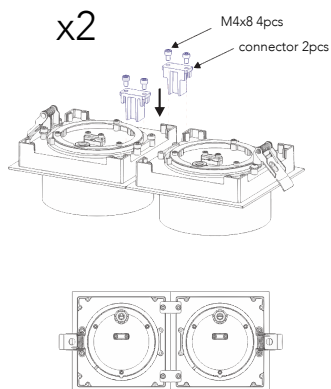

Three lamps mounting - Montaje tres lámparas

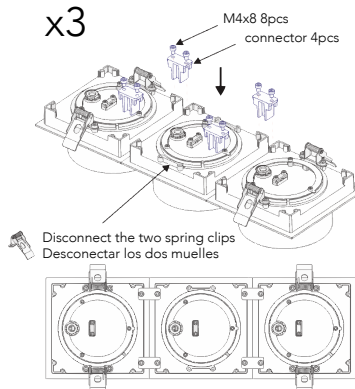

Four lamps mounting - Montaje cuatro lámparas

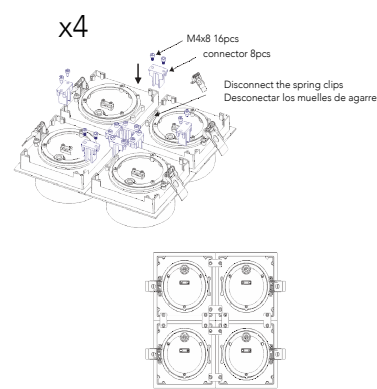

Optional features

CCT Range

- 5000K
- 6000K

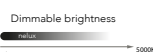
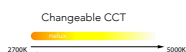



CROT



Product description

CROT series. High lumen output, high efficient lens. **Lower UGR < 16** . **LENS optics exchangeable**: oval, uniform and high intensity. Spot light series suitable for Hotels, retail shops, coffe-shops, offices, museums, private houses, private clinics. Led colour temperature 2700K, 3000K & 4000K as standards. Made from aluminum, electrostatic powder coating , reflectors made from PMMA, different angles available. Led drivers khün, osram, philips.

Accessories & options

- Khün, cree, samsung
- Dimmable (Triac, 0-10v)
- CRI>90 or above
- DALI
- Khün, osram,
- Dim to warm

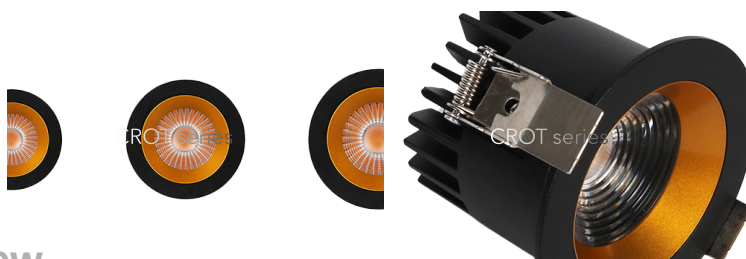

Crot series 15W-20W-30W

<p>DL9571.15</p> <p></p> <p>black white bright satin silver nickel</p> <p>Beam angle: 15°, 21°, 33°, 37°, 43°</p> <p>DL9571.15 - Input voltage AC220-240V Multivoltage 15W ~1300lm 2700K-3000K-4000K CRI>80 led cob citizen</p>	<p>DL11081.20</p> <p></p> <p>black white bright satin silver nickel</p> <p>Beam angle: 17°, 23°, 33°, 43°</p> <p>D11081.20 - Input voltage AC220-240V Multivoltage 20W ~1800lm 2700K-3000K-4000K CRI>80 led cob citizen</p>	<p>DL13595.30</p> <p></p> <p>black white bright satin silver nickel</p> <p>Beam angle: 16°, 24°, 31°, 36°</p> <p>DL13595.30 - Input voltage AC220-240V Multivoltage 30W ~2480lm 2700K-3000K-4000K CRI>80 led cob citizen</p>
---	---	--



Application ideas



Optional features

CCT Range

5000K

6000K

Changeable CCT

2700K ————— 5000K

Dimmable brightness

2700K ————— 5000K

CROT

CROT

Downlight

Downlight



CROT



Product description

UL approval **Deep anti-glare 6 sizes: 3W, 5W, 8W, 12W, 18W and 30W** to satisfy different lighting scenes Different beam angle 15° / 24° / 38° / 55° for option Step-type front ring color gold and white and black for selection

Accessories & options

- Khün, cree, samsung
- Dimmable (Triac, 0-10v)
- CRI>90 or above
- DALI
- Khün, osram,
- Dim to warm



CROT series 3W-5W-8W-12W-20W-25

DL4535.03



DL4535.03 - Input voltage AC220-240V Multivoltage
3W
~241lm 2700K-3000K-4000K
CRI>80
led cob bridgelux

DL5555.05



DL5555.05 - Input voltage AC220-240V Multivoltage
5W
~285lm 2700K-3000K-4000K
CRI>80
led cob bridgelux

DL6555.08



DL6555.08 - Input voltage AC220-240V Multivoltage
8W
~496lm 2700K-3000K-4000K
CRI>80
led cob bridgelux

DL7565.12



DL7565.12 - Input voltage AC220-240V Multivoltage
12W
~862lm 2700K-3000K-4000K
CRI>80
led cob bridgelux

DL10586.20

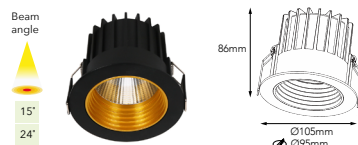

DL10586.20 - Input voltage AC220-240V Multivoltage
20W
~1591lm 2700K-3000K-4000K
CRI>80
led cob bridgelux

DL11593.25



DL11593.25 - Input voltage AC220-240V Multivoltage
25W
~2466lm 2700K-3000K-4000K
CRI>80
led cob bridgelux



Optional features

CCT Range

- 5000K
- 6000K

Changeable CCT

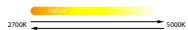

Dimmable brightness



CROT

CROT

Downlight

Downlight



ZAIN



Product description

ZAIN series made from aluminium, suitable for a variety of decoration style and scene application. Multiple beam angles options, to meet different lighting requirements. Embedded LED chip design, to protect human eyes effectively. wall washer series suitable for villa club, exhibition hall, and other commercial space like Hotels, retail shops, coffe-shops, offices, museums, private houses, private clinics. **Specially designed for private clinics, and clean areas available in 7W, 12W and 20W**

Accessories & options

- Khün, cree, samsung
- Dimmable (Triac, 0-10v)
- CRI>90 or above
- DALI
- Khün, osram,
- Dim to warm

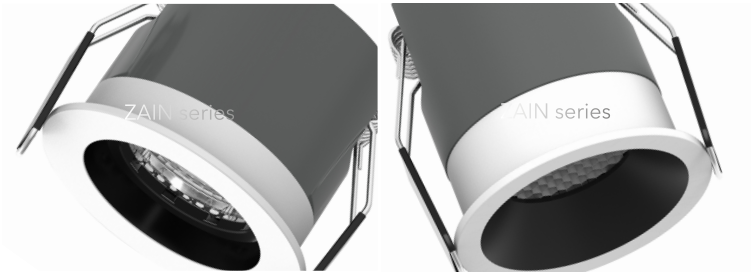

Zain series 7W-12W-20W

DL5949.07

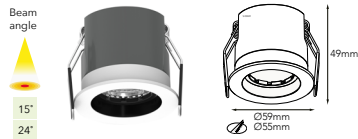
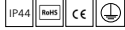

DL5949.07 - Input voltage AC220-240V Multivoltage 7W
~550lm 2700K-3000K-4000K
CRI>80
led cree cob

DL6052.07



DL6052.07 - Input voltage AC220-240V Multivoltage 7W
~500lm 2700K-3000K-4000K
CRI>80
led cree cob

DL7164.12

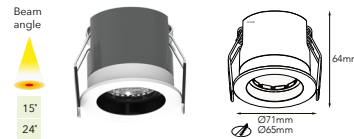

DL7164.12 - Input voltage AC220-240V Multivoltage 12W
~1200lm 2700K-3000K-4000K
CRI>80
led cree cob

DL7467.12

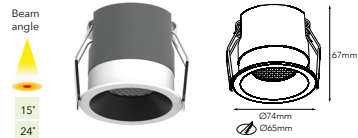

DL7467.12 - Input voltage AC220-240V Multivoltage 12W
~1050lm 2700K-3000K-4000K
CRI>80
led cree cob

DL8572.20

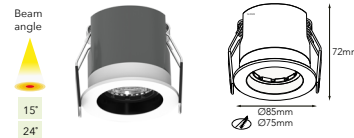

DL8572.20 - Input voltage AC220-240V Multivoltage 20W
~1900lm 2700K-3000K-4000K
CRI>80
led cree cob

DL8476.20

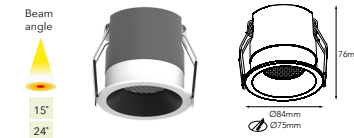

DL8476.20 - Input voltage AC220-240V Multivoltage 20W
~1850lm 2700K-3000K-4000K
CRI>80
led cree cob

Three size - two models

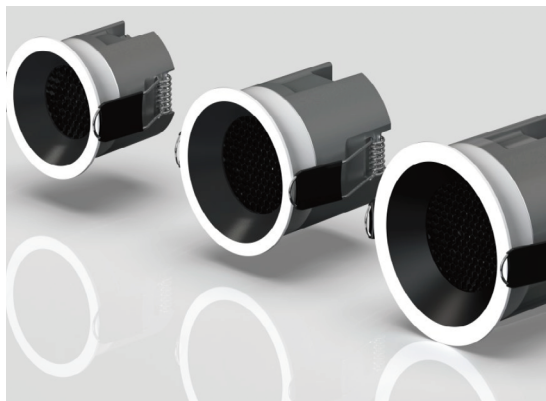

Optional features

CCT Range

- 5000K
- 6000K

Changeable CCT



Dimmable brightness





SILVEX



Product description

SILVEX series made from aluminium, a variety of colors for decorative cover are available, suitable for a variety of decoration style and scene application. Multiple beam angle options, to meet different lighting requirements. Embedded LED chip design, cut-off angle more than 30°, to protect human eyes effectively. **wall washer series suitable for Hotels**, retail shops, coffee-shops, offices, museums, private houses, private clinics. Led colour temperature 2700K, 3000K & 4000K as standards. Adjustable model. Three kind of reflectors, round reflector, elliptical reflector and semi-circular

Accessories & options

- Citizen, Luminus
- Dimmable (Triac, 0-10v)
- CRI>90 or above
- DALI
- Khün, osram, philips
- Dim to warm

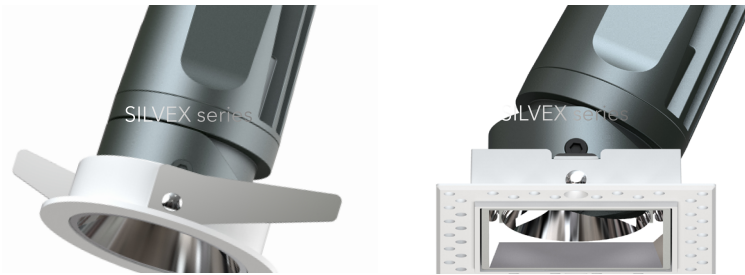

Silvex 8W series

WW6785.08 fixed

IP20



WW6785.08 - Input voltage AC220-240V Multivoltage 8W
~450lm 2700K-3000K-4000K
CRI>80
led citizen cob

WW7685TL.08 fixed trim-less

IP20



WW7685TL.08 - Input voltage AC220-240V Multivoltage 8W
~450lm 2700K-3000K-4000K
CRI>80
led citizen cob

WW6785.08AD adjustable

IP20



WW6785.08AD - Input voltage AC220-240V Multivoltage 8W
~450lm 2700K-3000K-4000K
CRI>80
led citizen cob

WW7685TL.08AD adjustable trim-less

IP20



WW7685TL.08AD - Input voltage AC220-240V Multivoltage 8W
~450lm 2700K-3000K-4000K
CRI>80
led citizen cob

WW67855.08 fixed

IP20

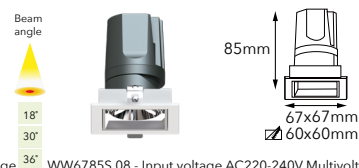

WW67855.08 - Input voltage AC220-240V Multivoltage 8W
~450lm 2700K-3000K-4000K
CRI>80
led citizen cob

WW76855-TL.08 fixed trim-less

IP20



WW76855-TL.08 - Input voltage AC220-240V Multivoltage 8W
~450lm 2700K-3000K-4000K
CRI>80
led citizen cob

WW76855-TL.08 fixed trim-less

IP20



WW76855-TL.08 - Input voltage AC220-240V Multivoltage 8W
~450lm 2700K-3000K-4000K
CRI>80
led citizen cob

WW76855-TL.08 fixed trim-less

IP20



WW76855-TL.08 - Input voltage AC220-240V Multivoltage 8W
~450lm 2700K-3000K-4000K
CRI>80
led citizen cob

Optional features

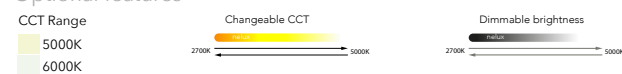

Anti-glare accessories

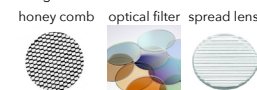

Optional reflectors





SILVEX



Product description

SILVEX series made from aluminium, a variety of colors for decorative cover are available, suitable for a variety of decoration style and scene application. Multiple beam angle options, to meet different lighting requirements. Embedded LED chip design, cut-off angle more than 30°, to protect human eyes effectively. **wall washer series suitable for Hotels, retail shops, coffee-shops, offices, museums, private houses, private clinics.** Led colour temperature 2700K, 3000K & 4000K as standards. **Adjustable model.** Three kind of reflectors, round reflector, elliptical reflector and semi-circular

Accessories & options

- Citizen, Luminus
- Dimmable (Triac, 0-10v)
- CRI > 90 or above
- DALI
- Khün, osram, philips
- Dim to warm



Silvex 6W-13W series

WW98108.13 fixed
IP20 RoHS CE

grey black white

Beam angle
18°
30°
36°

108mm
Ø 98mm
Ø 75mm

WW98108.13 - Input voltage AC220-240V Multivoltage
13W
~800lm 2700K-3000K-4000K
CRI>80
led citizen cob

WW86108TL.13 fixed trim-less
IP20 RoHS CE

grey black white

Beam angle
18°
30°
36°

108mm
Ø 86mm
Ø 75mm

WW86108TL.13 - Input voltage AC220-240V MultiV
13W
~800lm 2700K-3000K-4000K
CRI>80
led citizen cob

WW86106.013AD adjustable
IP20 RoHS CE

grey black white

Beam angle
18°
30°
36°

108mm
Ø 86mm
Ø 75mm

WW86106.013AD - Input voltage AC220-240V MultiV
13W
~780lm 2700K-3000K-4000K
CRI>80
led citizen cob

WW98108TL.13AD adjustable trim-less
IP20 RoHS CE

grey black white

Beam angle
18°
30°
36°

108mm
Ø 98mm
Ø 75mm

WW98108TL.13AD - Input voltage AC220-240V MultiV
13W
780lm 2700K-3000K-4000K
CRI>80
led citizen cob

WW86108.13 fixed
IP20 RoHS CE

grey black white

Beam angle
30°

108mm
Ø 86mm
Ø 75mm

WW86108.13 - Input voltage AC220-240V Multivoltage
13W
~500lm 2700K-3000K-4000K
CRI>80
led citizen cob

WW98108.TL.13 fixed trim-less
IP20 RoHS CE

grey black white

Beam angle
30°

108mm
Ø 98mm
Ø 75mm

WW98108.TL.13 - Input voltage AC220-240V MultiV
13W
~500lm 2700K-3000K-4000K
CRI>80
led citizen cob

WW86108-TL.06 fixed
IP20 RoHS CE

grey black white

Beam angle
15°
45°

108mm
Ø 86mm
Ø 75mm

WW86108-TL.06 - Input voltage AC220-240V MultiV
6W
~400lm 2700K-3000K-4000K
CRI>80
led citizen cob

WW98108-TL.06 fixed trim-less
IP20 RoHS CE

grey black white

Beam angle
15°
45°

108mm
Ø 98mm
Ø 75mm

WW7685S-TL.08 - Input voltage AC220-240V Multivoltage
6W
~400lm 2700K-3000K-4000K
CRI>80
led citizen cob

Optional features

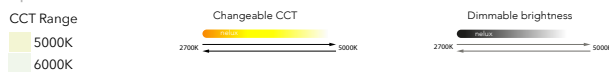

Anti-glare accessories

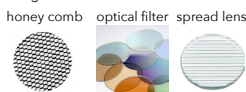

Optional reflectors





SILVEX



Product description

SILVEX series made from aluminium, a variety of colors for decorative cover are available, suitable for a variety of decoration style and scene application. Multiple beam angle options, to meet different lighting requirements. Embedded LED chip design, cut-off angle more than 30°, to protect human eyes effectively. **wall washer series suitable for Hotels, retail shops, coffee-shops, offices, museums, private houses, private clinics.** Led colour temperature 2700K, 3000K & 4000K as standards. Adjustable model. **Three kind of reflectors, round reflector, elliptical reflector and semi-circular**

Accessories & options

- Citizen, Luminus
- Dimmable (Triac, 0-10v)
- CRI > 90 or above
- DALI
- Khün, osram, philips
- Dim to warm

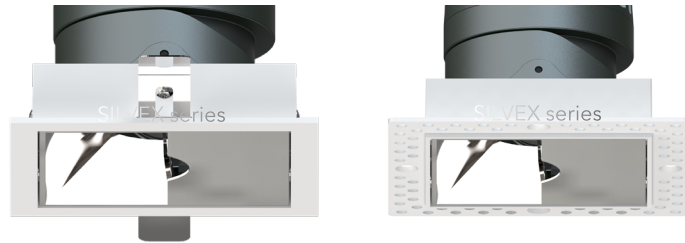

Silvex 6W-13W special reflectors series

<p>WW86108S.13 fixed</p> <p> </p> <p>Beam angle: 18°, 30°, 36°</p> <p>108mm height, 86x86mm diameter, 75x75mm base</p> <p>WW86108S.13 - Input voltage AC220-240V MultiV 13W ~800lm 2700K-3000K-4000K CRI>80 led citizen cob</p>	<p>WW98108S-TL.13 fixed trim-less</p> <p> </p> <p>Beam angle: 18°, 30°, 36°</p> <p>108mm height, 98x98mm diameter, 75x75mm base</p> <p>WW98108S-TL.13 - Input voltage AC220-240V MultiV 13W ~800lm 2700K-3000K-4000K CRI>80 led citizen cob</p>	<p>WW86106S.13AD adjustable</p> <p> </p> <p>Beam angle: 24°, 30°, 36°</p> <p>108mm height, 86x86mm diameter, 75x75mm base</p> <p>WW86106S.13AD - Input voltage AC220-240V MultiV 13W ~780lm 2700K-3000K-4000K CRI>80 led citizen cob</p>
<p>WW98108TL.13AD adjustable trim-less</p> <p> </p> <p>Beam angle: 24°, 30°, 36°</p> <p>108mm height, 98x98mm diameter, 75x75mm base</p> <p>WW98108TL.13AD - Input voltage AC220-240V MultiV 13W 780lm 2700K-3000K-4000K CRI>80 led citizen cob</p>	<p>WW86108S.13 fixed semi-reflector</p> <p> </p> <p>Beam angle: 30°</p> <p>108mm height, 86x86mm diameter, 75x75mm base</p> <p>WW86108S.13 - Input voltage AC220-240V MultiV 13W ~500lm 2700K-3000K-4000K CRI>80 led citizen cob</p>	<p>WW98108S-TL.13 fixed trim-less semi-reflector</p> <p> </p> <p>Beam angle: 30°</p> <p>108mm height, 98x98mm diameter, 75x75mm base</p> <p>WW98108S-TL.13 - Input voltage AC220-240V MultiV 13W ~500lm 2700K-3000K-4000K CRI>80 led citizen cob</p>
<p>WW86108S.06 adjustable</p> <p> </p> <p>Beam angle: 15°, ... 45°</p> <p>108mm height, 86x86mm diameter, 75x75mm base</p> <p>WW86108S.13 - Input voltage AC220-240V MultiV 6W ~400lm 2700K-3000K-4000K CRI>80 led citizen cob</p>	<p>WW98108S-TL.06 adjustable trim-less</p> <p> </p> <p>Beam angle: 15°, ... 45°</p> <p>108mm height, 98x98mm diameter, 75x75mm base</p> <p>WW98108S-TL.13 - Input voltage AC220-240V MultiV 6W ~400lm 2700K-3000K-4000K CRI>80 led citizen cob</p>	

Optional features

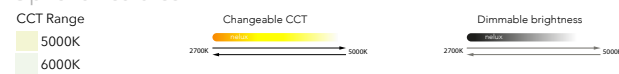

Anti-glare accessories

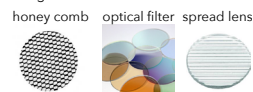

Optional reflectors



SILVEX

SILVEX

Downlight

Downlight



Product description

LAR series. Deep anti-glare UGR<16 Optics reflector for option: wall washer, adjustable and downlight
 two sizes: 15W and 20W FIXED AND TILTABLE . Elig series suitable for Hotels, retail shops, coffe-shops, offices, museums, private houses, private clinics. Led colour temperature 2700K, 3000K & 4000K as standards. Made from aluminum, electrostatic powder coating , different angles available. Led drivers khün, osram, philips.Integrated adapter driver

Accessories & options

- Cree
- Dimmable (Triac, 0-10v)
- Khün, osram, kegu
- DALI
- CRI>90 or above

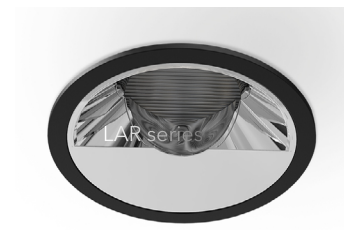

Lar series

DL110121A.20 Asymmetric-Deep antiglare wall washer



DL110121A.20 - Input voltage AC220-240V Multi-voltage
 20W
 ~1180lm 2700K-3000K-4000K
 CRI>80
 led cob citizen, bridgelux



DL90102.15 Asymmetric-Deep antiglare wall washer



DL90102A.15 - Input voltage AC220-240V Multi-voltage
 15W
 ~610lm 2700K-3000K-4000K
 led cob citizen, bridgelux



DL110121.20 Deep antiglare downlight



DL110121.20 - Input voltage AC220-240V Multi-voltage
 20W
 ~1740lm 2700K-3000K-4000K
 CRI>80
 led cob citizen



DL90102.15 Deep antiglare downlight



DL90102.15 - Input voltage AC220-240V Multivoltage
 15W
 ~970lm 2700K-3000K-4000K
 CRI>80
 led cob bridgelux



DL110121T.20 Deep antiglare downlight Tiltable

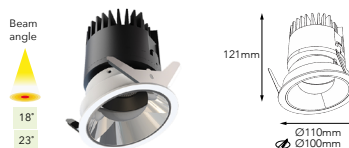

DL110121T.20 - Input voltage AC220-240V Multi-voltage
 20W
 ~1940lm 2700K-3000K-4000K
 CRI>80
 led cob bridgelux



DL90102T.15 Deep antiglare downlight Tilttable



DL90102T.15 - Input voltage AC220-240V Multi-voltage
 15W
 ~1020lm 2700K-3000K-4000K
 CRI>80
 led cob bridgelux



Optional features

CCT Range

- 5000K
- 6000K

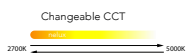

Reflector or lens



LAR

LAR

Downlight

Downlight

SURFACE CEILING LIGHT

Upgrade your projects as restaurant, rooms, hotels , private clinics, offices, retail shops, for the chance to enjoy new design with nelux surface ceiling light giving a chic touch to your lighting projects.

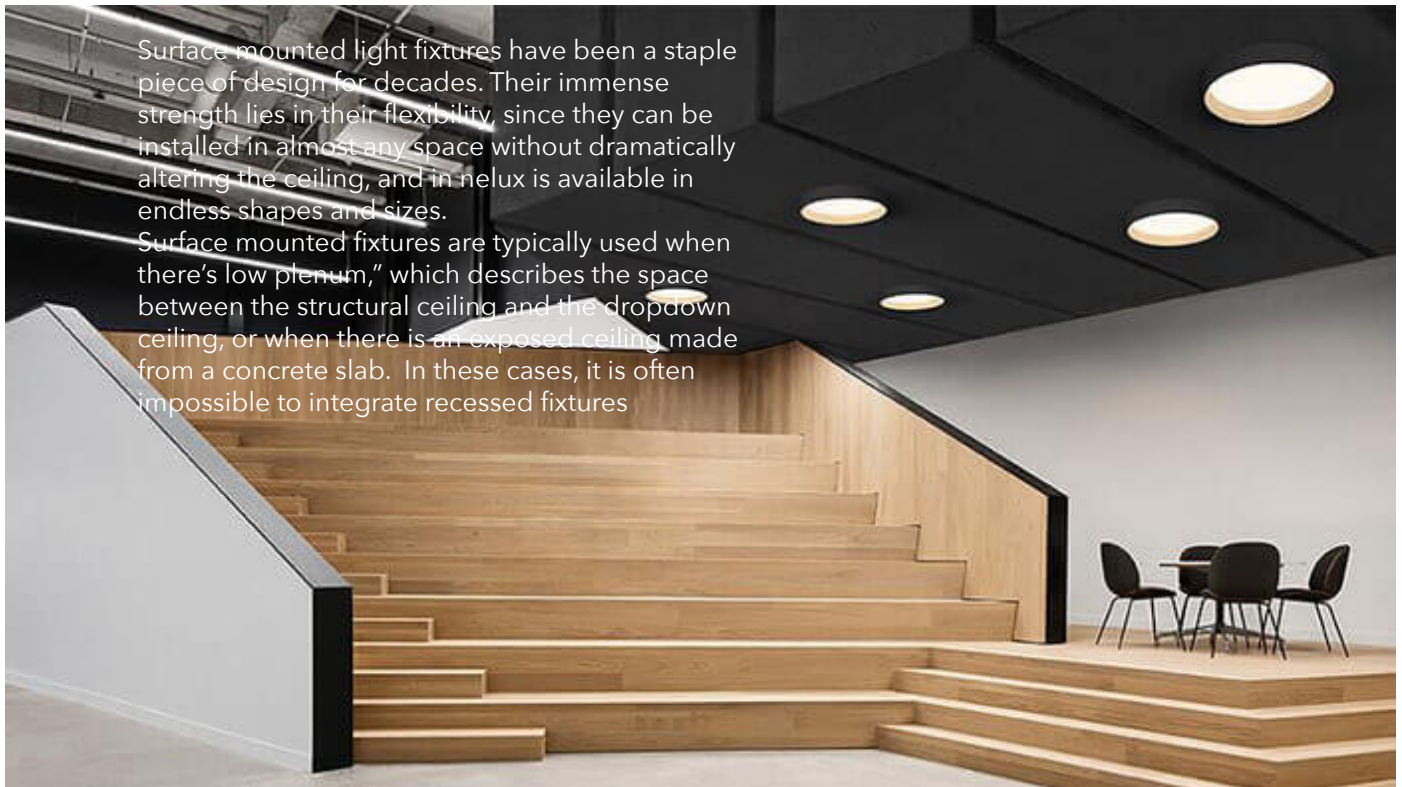

Surface mounted light fixtures have been a staple piece of design for decades. Their immense strength lies in their flexibility, since they can be installed in almost any space without dramatically altering the ceiling, and in nelux is available in endless shapes and sizes. Surface mounted fixtures are typically used when there's low plenum," which describes the space between the structural ceiling and the dropdown ceiling, or when there is an exposed ceiling made from a concrete slab. In these cases, it is often impossible to integrate recessed fixtures

Los productos de iluminación montados en superficie han sido y son una pieza básica de diseño. Su inmensa fuerza radica en su flexibilidad pues se pueden instalar en casi cualquier espacio sin alterar drásticamente el techo, y en nelux tenemos una gran variedad con infinitas formas, tamaños, y potencias.

Los accesorios montados en la superficie se utilizan normalmente cuando el espacio entre el techo estructural y el falso techo es muy pequeño, o cuando hay un techo construido de una losa de hormigón.

En estos casos, a menudo es complicado integrar luminarias empotradas, y recomendamos nuestros productos de instalación en superficie.

Surface ceiling light

PLAFON 12W-18W-25W series



PLAFON 18W-30W-36W series



PLAFON 18W-36W-48W series



KARSI 10W series



BLO 6W-12W-15W-20W series

In Nelux you will find a great variety of surface mounted lighting for your next project. If you want to know more products you can also order our catalog 2020 or check our website www.valentiae.com. Surface mounted light fixtures have been a staple piece of design for your projects. Their immense strength lies in their flexibility, since they can be installed in almost any space without dramatically altering the ceiling, and are available in endless shapes and sizes.

In nelux we advise you about our big range of surface ceiling lights for private houses, hotel lobby, retail shops, commercial mall, public areas, terrace, corridors, private clinics. All our series create a relaxed ambiance or bright functional lighting depending on your specific requirements for your lighting projects. You can choose among 10W to 48W to satisfy your expectations.

Please remember, you must follow the strict electrical safety regulations of your country and pay attention to IP ratings.



PLAFON SATUR



Product description

PLAFON series. Materials Aluminum and PC. IP54 suitable for bathroom, stair, corridor. Tough PC cover, IK10. (strong enough to bear around 40KGS) Ultra slim design (6.2cm thickness), Light soft, no dark shadow. CCT change (3000K/4000K/5000K) and dimmable is available. 3hrs Emergency light on your path in Dark night, and microwave sensor is available. **Tuya Bluetooth and wifi APP control is available**. **Interchangeable bezels**, polish chrome, stain nickel, black, or OEM color available.



Accessories & options

- Sanan, Luminus,
- Dimmable (Triac, 0-10v)
- CRI > 90 or above
- DALI
- Khün, osram, philips
- Dim to warm



Plafon 12W-18W-25W series

PF25055.12

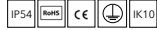

PF25055.12 - Input voltage AC220-240V Multivoltage
12W
~1200lm 3000K-4000K-5000K
CRI > 80
led SMD2835 sanan

PF30055.18

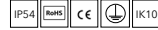

PF30055.18 - Input voltage AC220-240V Multivoltage
18W
~1900lm 3000K-4000K-5000K
CRI > 80
led SMD2835 sanan

PF38055.25

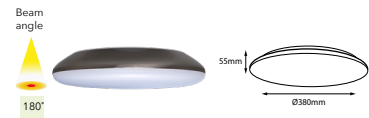
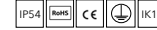

PF38055.25 - Input voltage AC220-240V Multivoltage
25W
~2600lm 3000K-4000K-5000K
CRI > 80
led SMD2835 sanan

Polished chrome - Brushed chrome - Golden



Tuya Bluetooth and wifi APP control is available and CCT change, dimming by smart home APP



Installation



Optional features

CCT Range

- 5000K
- 6000K

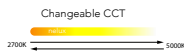



PLAFON PILL



Product description

PLAFON series. Materials Aluminum and PC. **IP54 suitable for bathroom, stair, corridor Tough PC cover, IK10.** (strong enough to bear around 40KGS) Ultra slim design(6.2cm thickness), Light soft, no dark shadow. CCT change(3000K/4000K/5000K) and dimmable is available 3hrs Emergency(light on your path in Dark night), and microwave sensor is available. Tuya Bluetooth and wifi APP control is available . Interchangeable bezel, polish chrome, stain nickle, black, or OEM color available.

Accessories & options

- Philips, Samsung
- Khün, osram, kegu
- CRI>90 or above
- Dimmable (Triac, 0-10v)
- DALI



Plafon 18W-30W-36W series

PF30058.18 Dimmable or non-dimmable

IP44 black white

Beam angle 180°

58mm Ø300mm

PF30058.18 - Input voltage AC220-240V Multivoltage
18W
~1440lm 3000K-4000K-5000K
CRI>80
led epistar SMD

PF30058SS.18 Sensor - non-dimmable

IP44 black white

Beam angle 180°

58mm Ø300mm

PF30058SS.18 -Input voltage AC220-240V Multi-voltage
18W
~1440Lm 3000K-4000K-5000K
CRI>80
led epistar SMD

PF40065.30 Standard - Dimmable or non-dimmable

IP44 black white

Beam angle 180°

65mm Ø400mm

PF40065.30 - Input voltage AC220-240V Multivoltage
30W
~2400lm 3000K-4000K-5000K
CRI>80
led epistar SMD

PF40065SS.30 Sensor - non-dimmable

IP44 black white

Beam angle 180°

65mm Ø400mm

PF40065SS.30 - Input voltage AC220-240V Multi-voltage
30W
~2400lm 3000K-4000K-5000K
CRI>80
led epistar SMD

PF50065.36 Standard - Dimmable or non-dimmable

IP44 black white

Beam angle 180°

65mm Ø500mm

PF50065.36 - Input voltage AC220-240V Multivoltage
36W
~2880Lm 3000K-4000K-5000K
CRI>80
led epistar SMD

PF50065SS.36 Sensor - non-dimmable

IP44 black white

Beam angle 180°

65mm Ø500mm

PF50065SS.36 - Input voltage AC220-240V Multi-voltage
36W
~2880lm 3000K-4000K-5000K
CRI>80
led epistar SMD

PF60065.36 Standard - Dimmable or non-dimmable

IP44 black white

Beam angle 180°

65mm Ø600mm

PF60065.36 - Input voltage AC220-240V MultiV
36W
~4000lm 3000K-4000K-5000K
CRI>80
led epistar SMD

PF60065SS.36 Sensor - non-dimmable

IP44 black white

Beam angle 180°

65mm Ø600mm

PF60065SS.36 -Input voltage AC220-240V MultiV
36W
~4000Lm 3000K-4000K-5000K
CRI>80
led epistar SMD

Optional features

CCT Range

- 5000K
- 6000K

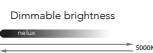
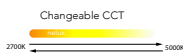

Available frames under demand

- yellow
- red
- green
- purple

PLAFON

PLAFON

Surface ceiling light

Surface ceiling light



PLAFON DIAMOND



Product description

PLAFON square series, Materials Aluminum and PC, IP20 suitable for private houses, corridor Tough PC cover. **Ultra slim design(68mm & 78mm thickness)**, Light soft, no dark shadow. CCT change(3000K/4000K/5000K) and **remote controller available**.

Accessories & options

- Sanan, Hongli
- Dimmable (Triac, 0-10v)
- CRI>90 or above
- DALI
- Khün, osram, philips
- Dim to warm

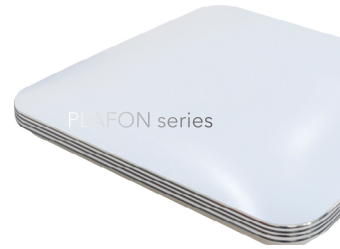

Plafon 18W-36W-48W series

PF3333NE.18 without edge

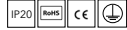

PF3333NE.18 Input voltage AC220-240V Multivoltage 18W
~1350lm 3000K-4000K-5000K
CRI>80
led hongli SMD

PF4343NE.36 without edge



PF4343NE.36-Input voltage AC220-240V MultiV 36W
~2700Lm 3000K-4000K-5000K
CRI>80
led hongli SMD

PF5353NE.48 | PF5353NE.36 without edge

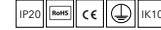

PF5353NE.48 | PF5353NE.36 AC220-240V MultiV 48W | 36W
~3600lm | ~2700lm 3000K-4000K-5000K
CRI>80
led hongli SMD

PF3333SE.18 silver edge

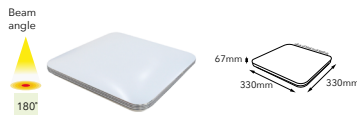

PF3333SE.18 Input voltage AC220-240V Multivoltage 18W
~1350lm 3000K-4000K-5000K
CRI>80
led hongli SMD

PF4343SE.36 silver edge

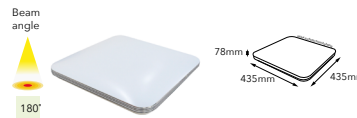

PF4343SE.36-Input voltage AC220-240V MultiV 36W
~2700Lm 3000K-4000K-5000K
CRI>80
led hongli SMD

PF5353SE.48 | PF5353NE.36 silver edge

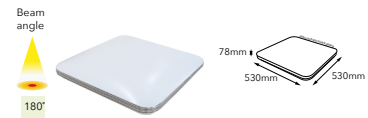
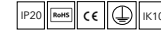

PF5353SE.48 | PF5353NE.36 AC220-240V MultiV 48W | 36W
~3600lm | ~2700lm 3000K-4000K-5000K
CRI>80
led hongli SMD

PF3333WE.18 wooden edge

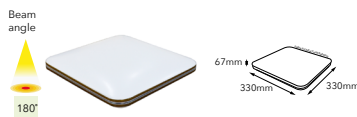

PF3333WE.18 Input voltage AC220-240V Multivoltage 18W
~1350lm 3000K-4000K-5000K
CRI>80
led hongli SMD

PF4343WE.36 wooden edge

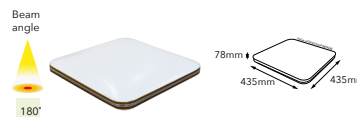

PF4343WE.36-Input voltage AC220-240V MultiV 36W
~2700Lm 3000K-4000K-5000K
CRI>80
led hongli SMD

PF5353WE.48 | PF5353NE.36 wooden edge

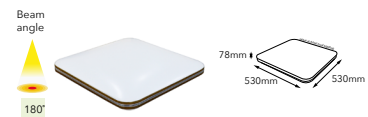
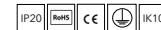

PF5353WE.48 | PF5353NE.36 AC220-240V MultiV 48W | 36W
~3600lm | ~2700lm 3000K-4000K-5000K
CRI>80
led hongli SMD

Optional features

CCT Range

- 5000K
- 6000K

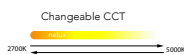

Remote controller available



Surface ceiling light

Surface ceiling light



KARSI



Product description

KARSI series, Made from aluminum die casting. Different beam angles available for your special lighting projects. Applied to hotels, retail shops, restaurants, private clinics, private houses,apartments, different areas to enhance your lighting projects. Led colour temperature 3000K & 4000K as standards. **Karsi options fixed and adjustable**

Accessories & options

- Led Osram
- Dimmable (Triac, 0-10v)
- CRI>90 or above
- DALI
- Khün, osram, kegu
- Dim to warm



KARSI 10W series

CS111168.10
IP20

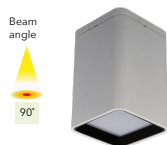

CS111168.10- Input voltage AC220-240V Multivoltage 10W
~840lm - 3000K-4000K-5000K-6500K
CRI>80
led Osram SMT

CS111168A.10 Adjustable
IP20

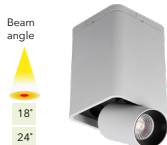

CS111168A.10 - Input voltage AC220-240V MultiV 10W
~720lm - 3000K-4000K
CRI>80
led Cree cob
Optional optical components: lens, honeycomb

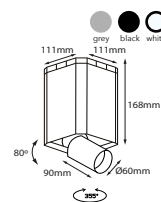

Optional features

CCT Range
5000K
6000K

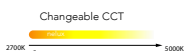

Surface ceiling light

Surface ceiling light



ELVOU



Product description

ELVOU surface spotlight series suitable for Hotels, retail shops, coffe-shops, offices, museums, private houses, private clinics. Led colour temperature 3000K & 4000K & 5000K as stand-ards. Multiple beam angle options to meet different lighting requirements. Finished color gold, red gold, and standards black , grey, white. **High end design**

Accessories & options

- Philips, Samsung
- Khün, osram, kegu
- CRI > 90 or above
- Dimmable (Triac)
- DALI



Elvou 12W-18W series

CS80108. 12

IP20

Beam angle: 12°, 24°, 36°

40mm height, Ø 80mm diameter

CS80108. 12 - Input voltage AC220-240V Multivoltage 12W ~1000lm 3000K-4000K-5000K CRI>90 led epistar SMD

CS100135.18

IP20

Beam angle: 12°, 24°, 36°

40mm height, Ø 100mm diameter

CS100135.18 - Input voltage AC220-240V Multivoltage 18W ~1600Lm 3000K-4000K-5000K CRI>90 led epistar SMD

CS80108T. 12

IP20

Beam angle: 12°, 24°, 36°

108mm height, Ø 80mm diameter

CS80108T. 12 - Input voltage AC220-240V Multivoltage 12W ~1000lm 3000K-4000K-5000K CRI>90 led Cree

CS80188T. 12

IP20

Beam angle: 12°, 24°, 36°

188mm height, Ø 80mm diameter

CS80188T. 12 - Input voltage AC220-240V Multivoltage 12W ~1000lm 3000K-4000K-5000K CRI>90 led Cree

CS80268T. 12

IP20

Beam angle: 12°, 24°, 36°

268mm height, Ø 80mm diameter

CS80268T. 12 - Input voltage AC220-240V MultiV 12W ~1000lm 3000K-4000K-5000K CRI>90 led Cree

CS100135T. 12

IP20

Beam angle: 12°, 24°, 36°

135mm height, Ø 100mm diameter

CS100135T. 12 - Input voltage AC220-240V MultiV 12W ~1000lm 3000K-4000K-5000K CRI>90 led Cree

CS100235T. 12

IP20

Beam angle: 12°, 24°, 36°

235mm height, Ø 100mm diameter

CS100235T. 12 - Input voltage AC220-240V MultiV 12W ~1000lm 3000K-4000K-5000K CRI>90 led Cree

CS100335T. 12

IP20

Beam angle: 12°, 24°, 36°

335mm height, Ø 100mm diameter

CS100335T. 12 - Input voltage AC220-240V MultiV 12W ~1000lm 3000K-4000K-5000K CRI>90 led Cree

Optional features

CCT Range

 2700K
 6000K

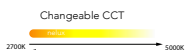

Surface ceiling light

Surface ceiling light



BLO



Product description

BLO surface ceiling light series suitable for Hotels, retail shops, coffe-shops, offices, museums, private houses, private clinics. Led colour temperature 2700K, 3000K & 4000K as standards. Multiple beam angle options to meet different lighting requirements. Finished color white, black or silver.

Accessories & options

- Led Osram
- Dimmable (Triac, 0-10v)
- CRI>90 or above
- DALI
- Khün, osram, kegu
- Dim to warm

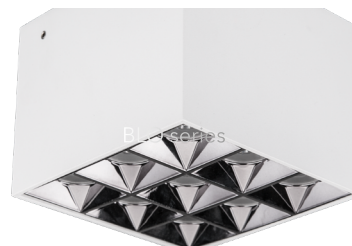

Blo series

CL8080.06 Surface
IP44

silver black white

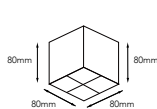
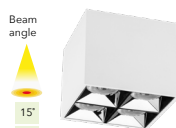

CL8080.06 Input voltage AC220-240V - Multivoltage
6W
~549lm - 2700K-3000K-4000K
CRI>90
led Osram SMD

CL8080.12 Surface
IP44

silver black white

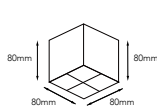
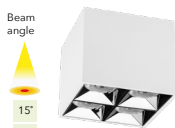

CL8080.12 Input voltage AC220-240V - Multivoltage
12W
~916lm - 2700K-3000K-4000K
CRI>90
led Osram SMD

CL12080.15 Surface
IP44

silver black white

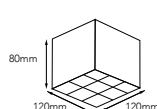
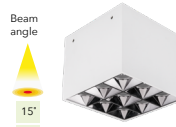

CL12080.15 Input voltage AC220-240V - Multivoltage
15W
1338lm - 2700K-3000K-4000K
CRI>90
led Osram SMD

CL12080.20 Surface
IP44

silver black white

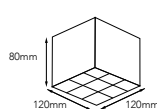
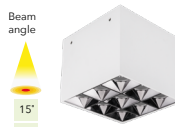

CL12080.20 Input voltage AC220-240V - Multivoltage
12W
~1574lm - 2700K-3000K-4000K
CRI>90
led Osram SMD



Application ideas



Optional features

CCT Range
5000K
6000K

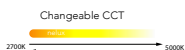

Surface ceiling light

Surface ceiling light

REMOTE CONTROL LIGHT

Upgrade your projects as restaurant, rooms, hotels , private clinics, offices, retail shops, for the chance to enjoy new design giving a chic touch.



This Remote Control Track Light Is Made Of Die Cast Aluminum,By Using The New Generation LED Chip. It Creates Adjustable Beam Angle,Color Temperature And Illumination. It Can Meet The Needs Of Different Scenarios 350 degree Horizontal Rotation, 90degree Vertical Rotation. Mounted With 3 Circuit Tracks. Suitable For Use In Areas Like Fancy Store,Gallery,Museum,Hotels, Restaurants, creating different scenes.

Los productos de carril/riel y empotrables que disponemos en esta serie son de control remoto fabricados en inyección de zamak, utilizando chips LED de nueva generación. Obtenemos ángulos de haz, temperatura de color e iluminación ajustables.

Con estos productos satisfacemos las necesidades de diferentes escenarios Rotación horizontal de 350 grados, rotación vertical de 90 grados. Montado con 3 pistas de circuito. Adecuado para uso en áreas como tiendas de lujo, galerías, museos, hoteles, restaurantes, creando diferentes escenas.

Remote control light

MOTORIZED Track light max.50W, max30W, max.20W series



MOTORIZED downlight Laser control max.15,max.30W, max.40W series



Remote control light

Remote control light

In Nelux you will find a great variety of track light and downlight remote control light for your coming projects. Remote control lighting products are an avant-garde piece of design for your projects. Their immense strength lies in their flexibility, changeable brightness, changeable CCT and luminous flux. In nelux we advise you about our big range of remote control light for private houses, hotel lobby, retail shops, commercial mall, public areas, terrace, corridors, private clinics. All our series create a relaxed ambiance or bright functional lighting depending on your specific requirements for your lighting projects. You can choose among different power to satisfy your expectations.

Please remember, you must follow the strict electrical safety regulations of your country and pay attention to IP ratings.



MOTORIZED track light



Product description

MOTORIZED Track light Aluminum die-cast body. product is multi-functional, with automatic 0-355D horizontal Rotatable, 0-30D vertical tiltable, 2700K-5000K color temperature changeable and 100%-0% dimming functions, and all controlled by one remote. Using mobile App or remote control to trigger its connection to the light, to adjust the lighting direction, CCT and lumen of the lamp. Series suitable for Hotels, retail shops, coffee-shops, offices, museums, private houses, private clinics. If you need more information contact us or be a member in www.valentiae.com and we will leave all your information in your personal page.

Options

Remote Control independent works directly via RF433M wireless protocol communication. Max support 999 channels. Several lamps to be set in the same channel is available.

Mobile APP control is by sending command via RF433 Router. Max. Support 999 Channels. Several lamps to be set in the same channel is available.



MOTORIZED

MOTORIZED

Motorized track light series

TM80136C (3 functions)



TM80136C - Input voltage AC220-240V Multivoltage
Max 30W
Max ~2218lm 2700-5000K
CRI>90
led cob citizen

TM80136DA (2 functions)



TM80136DA - Input voltage AC220-240V Multivoltage
Max 30W
Max ~2218lm 2700-5000K
CRI>90
led cob citizen

TM80136B (1 function)



TM80136B - Input voltage AC220-240V Multivoltage
Max 30W
Max ~2218lm 2700-5000K
CRI>90
led cob citizen

TM90160C (3 functions)



TM90160C - Input voltage AC220-240V Multivoltage
Max 50W
Max ~2218lm 2700-5000K
CRI>90
led cob samsung

TM90160DA (2 functions)



TM90160DA - Input voltage AC220-240V Multivoltage
Max 50W
Max ~2218lm 2700-5000K
CRI>90
led cob citizen

TM90160B (1 function)



TM90160B - Input voltage AC220-240V Multivoltage
Max 50W
Max ~2218lm 2700-5000K
CRI>90
led cob citizen

TM90160DA (2 functions)



TM90160DA - Input voltage AC220-240V Multivoltage
20W
~1342lm 2700-5000K
CRI>90
led cob citizen

TM90160C (3 functions)



TM90160C - Input voltage AC220-240V Multivoltage
20W
~1342lm 2700-5000K
CRI>90
led cob samsung

Remote control light

Remote control light



MOTORIZED down light



Product description

REMOTE CONTROL Down light by laser Aluminum die- cast body. product is multi-functional, with automatic 0-355D horizontal Rotatable, 0-30D vertical tiltable, 2700K-5000K color temperature changeable and 100%-0% dimming functions, and all controlled by one remote. The remote uses laser signal to trigger its connection to the light, and then it uses RF433 signal to adjust the lighting direction, CCT and lumen of the lamp. Series suitable for Hotels, retail shops, coffee-shops, offices, museums, private houses, private clinics. If you need more information contact us or be a member in www.valentia.com and we will leave all your information in your personal page.

Options

Remote Control independent works directly via RF433M wireless protocol communication. Max support 999 channels. Several lamps to be set in the same channel is available.



MOTORIZED

MOTORIZED

Motorized down light Lase control series

DM195220 max 40W (2 functions)



DM195220 - Input voltage AC220-240V Multivoltage
Max 40W
Max ~3200lm 2700-5000K
CRI>90
led cob samsung



DM160185 max 30W (2 functions)



DM160185 - Input voltage AC220-240V Multivoltage
Max 30W
Max ~2400lm 2700-5000K
CRI>90
led cob samsung



TM80136B (1 function)



TM80136B - Input voltage AC220-240V Multivoltage
Max 30W
Max ~2218lm 2700-5000K
CRI>90
led cob citizen



Application ideas



Remote control light

Remote control light

TRACK HEAD LIGHT

Upgrade your projects as restaurant, rooms, hotels , private clinics, offices, retail shops, for the chance to enjoy new design with nelux new track head lights giving a chic touch.

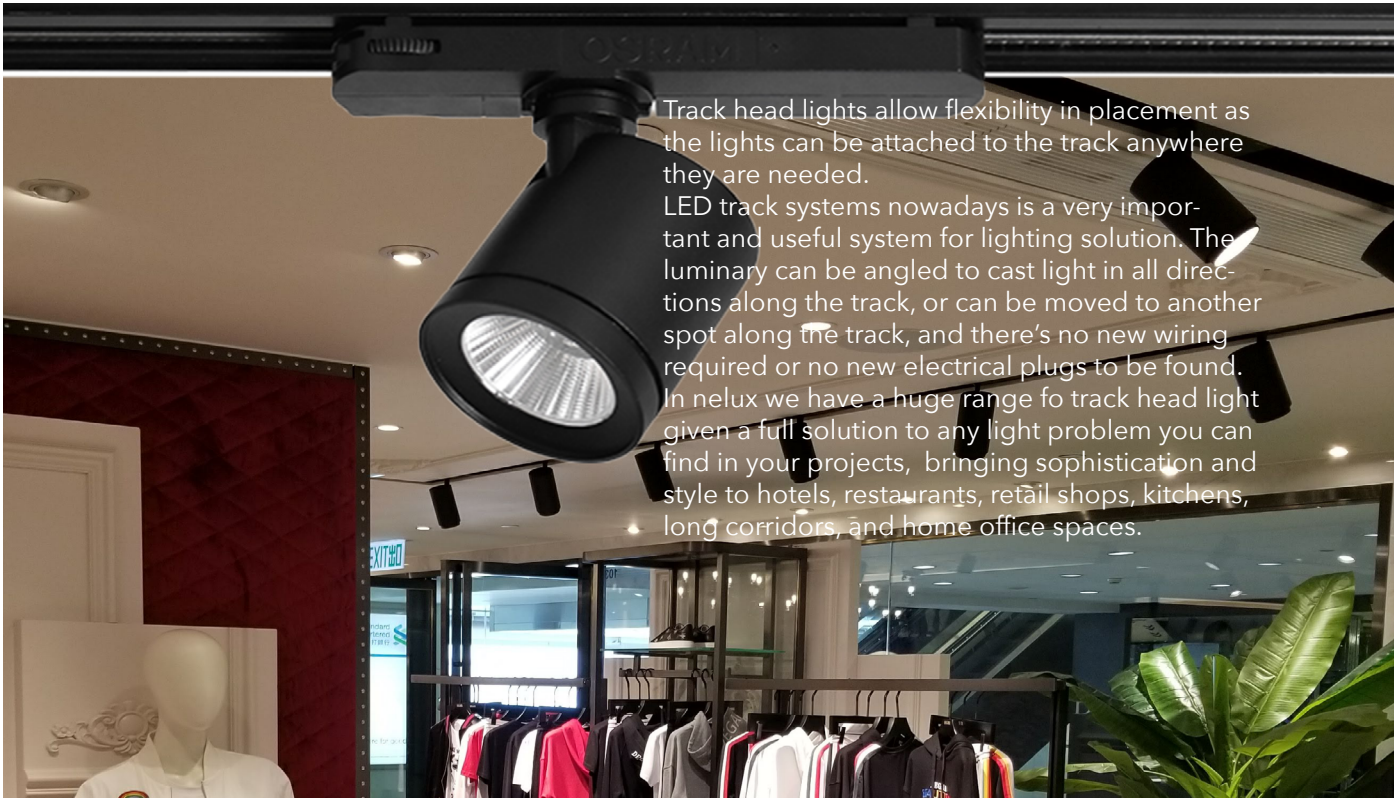

Track head lights allow flexibility in placement as the lights can be attached to the track anywhere they are needed. LED track systems nowadays is a very important and useful system for lighting solution. The luminary can be angled to cast light in all directions along the track, or can be moved to another spot along the track, and there's no new wiring required or no new electrical plugs to be found. In nelux we have a huge range fo track head light given a full solution to any light problem you can find in your projects, bringing sophistication and style to hotels, restaurants, retail shops, kitchens, long corridors, and home office spaces.

Los proyectores para carril/riel permiten una gran flexibilidad en su instalaci[on y colocaci[on, ya que las luces se pueden unir al carril/riel en cualquier lugar donde se necesiten.

Los sistemas de carril/riel LED hoy en d[ia son un sistema muy importante y [u]til para la soluci[on de iluminaci[on. La luminaria se puede inclinar para proyectar luz en todas las direcciones a lo largo del carril/riel, o se puede mover a otro lugar a lo largo del carril/riel, y no se requiere cableado nuevo ni enchufes el[ectricos nuevos. En nelux contamos con una amplia gama de proyectores de carril/riel que dan una soluci[on completa a cualquier problema de iluminaci[on que pueda encontrar en sus proyectos, aportando sofisticaci[on y estilo a hoteles, restaurantes, tiendas, cocinas, pasillos, oficinas, colegios, institutos..

nelux architectural lighting



Track head light

In nelux we advise you about spotlights for private houses, hotel lobby, retail shops, commercial mall, public areas, terrace. All our series create a relaxed ambiance or bright functional lighting, depending on your specific requirements for your lighting projects.



Track head lights

RIN series 15W-20W-28W-4x10W-9x5W



HOFF series 8W-10W-15W-20W-25W-30W-35W-40W-Zoomer



VOTI zoom series 15W-30W

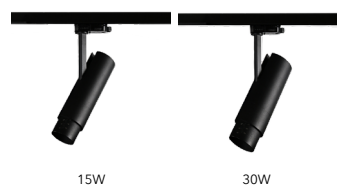

VOTI series 8W-12W-20W-30W



Please remember, you must follow the strict electrical safety regulations of your country and pay attention to IP ratings.

nelux architectural lighting



Track head light

In nelux we advise you about spotlights for private houses, hotel lobby, retail shops, commercial mall, public areas, terrace. All our series create a relaxed ambiance or bright functional lighting, depending on your specific requirements for your lighting projects.



Track head lights

VOTI series 7W-10W-12W-18W-20W-30W



VANZO series 11W

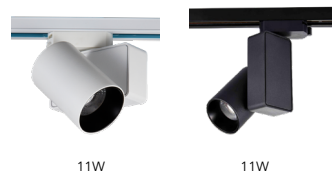

FOSO series 10W-20W-28W-35W



Track head light

Track head light

Please remember, you must follow the strict electrical safety regulations of your country and pay attention to IP ratings.



RIN round



Product description

CLASS track head light series suitable for Hotels, retail shops, coffe-shops, offices, museums, private houses, private clinics. Led colour temperature 2700K, 3000K & 4000K as standards. Curve and curve tube models. Made from aluminum, electrostatic powder coating , reflectors made from PMMA, different angles available. Led drivers khün, osram, philips.

Accessories & options

- Philips, Samsung
- Khün, osram, kegu
- CRI>90 or above
- Dimmable (Triac, 0-10v)
- DALI



Rin round series

TL120131 - 15W

black white grey

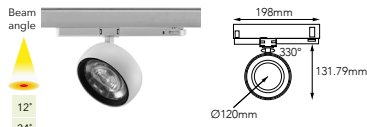

TL120131 - Input voltage AC220-240V Multivoltage 15W
 ~1400lm 2700K-3000K-4000K
 CRI>80 CRI>90
 led cob luminus



TL120131 - 20W

black white grey



TL120131 - Input voltage AC220-240V Multivoltage 20W
 ~1780lm 2700K-3000K-4000K
 CRI>80 CRI>90
 led cob luminus



TL120131 - 28W

black white grey



TL120131 - Input voltage AC220-240V Multivoltage 28W
 ~2250lm 2700K-3000K-4000K
 CRI>80 CRI>90
 led cob luminus



TL111127 15W

black white grey



TL111127 - Input voltage AC220-240V Multivoltage 15W
 ~1400lm 2700K-3000K-4000K
 CRI>80 CRI>90
 led cob luminus



TL111127 20W

black white grey



TL111127 - Input voltage AC220-240V Multivoltage 20W
 ~1780lm 2700K-3000K-4000K
 CRI>80 CRI>90
 led cob luminus



TL111127 28W

black white grey



TL111127 - Input voltage AC220-240V Multivoltage 28W
 ~2250lm 2700K-3000K-4000K
 CRI>80 CRI>90
 led cob luminus



Optional features

- CCT Range
- 5000K
 - 6000K

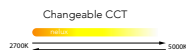

Track head light

Track head light



RIN square



Product description

CLASS square track head light series suitable for Hotels, retail shops, coffe-shops, offices, museums, private houses, private clinics. Led colour temperature 2700K, 3000K & 4000K as standards. Made from aluminum, electrostatic powder coating, reflectors made from PMMA, different angles available. Led drivers khün, osram, philips.

Accessories & options

- Philips, Samsung
- Khün, osram, kegu
- CRI>90 or above
- Dimmable (Triac, 0-10v)
- DALI



RIN

RIN

Rin series

TL9595 - 20W



black white grey

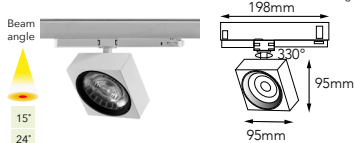

TL9595 - Input voltage AC220-240V Multivoltage 20W
~1766lm 2700K-3000K-4000K
CRI>80 CRI>90
led cob luminus

TL9595 - 28W



black white grey

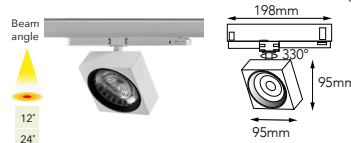

TL9595 - Input voltage AC220-240V Multivoltage 28W
~2380lm 2700K-3000K-4000K
CRI>80 CRI>90
led cob luminus

RIN dots series

TL145145 - 4x10W



black white grey



TL145145 - Input voltage AC220-240V Multivoltage 4x10W
~3800lm 2700K-3000K-4000K
CRI>80 CRI>90
led cob luminus

TL145145 - 9x5W



black white grey



TL145145 - Input voltage AC220-240V Multivoltage 9x5W
~4000lm 2700K-3000K-4000K
CRI>80 CRI>90
led cob luminus



Optional features

CCT Range

- 5000K
- 6000K

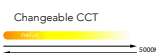

Track head light

Track head light



HOFF



Product description

Hoff track head light series suitable for Hotels, retail shops, coffe-shops, offices, museums, private houses, private clinics. Led colour temperature 2700K, 3000K & 4000K as standards. Made from die-cast aluminum, electrostatic powder coating , reflectors made from aluminum high standards, different angles available. Led drivers khün, osram, philips.

Accessories & options

- Philips, Samsung
- Khün, osram, kegu
- CRI>90 or above
- Dimmable (Triac, 0-10v)
- DALI



Hoff series

TS65105.10 Reflector



black white grey



Beam angle
20°
30°
40°
TS65105.10 - Input voltage AC220-240V Multivoltage 10W
~880lm 2700K-3000K-4000K
CRI>80 CRI>90
led cob citizen

TS75145.20 Reflector



black white grey



Beam angle
15°
24°
38°
TS75145.20 - Input voltage AC220-240V Multivoltage 20W
~1790lm 2700K-3000K-4000K
CRI>80 CRI>90
led cob citizen

TS85165.30 Reflector



black white grey



Beam angle
15°
24°
38°
TS85165.30 - Input voltage AC220-240V Multivoltage 30W
~2780lm 2700K-3000K-4000K
CRI>80 CRI>90
led cob citizen

TS95195.40 Reflector

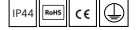

black white grey



Beam angle
15°
24°
38°
TS95195.40 - Input voltage AC220-240V Multivoltage 40W
~3840lm 2700K-3000K-4000K
CRI>80 CRI>90
led cob citizen

TL65185.30 Lens



black white grey



Beam angle
12°
24°
36°
60°
TL65185.30 - Input voltage AC220-240V Multivoltage 30W
~2150lm 2700K-3000K-4000K
CRI>90
led cob luminus

TL65160.30 Lens



black white grey



Beam angle
12°
24°
36°
TL65160.30 - Input voltage AC220-240V Multivoltage 30W
~2150lm 2700K-3000K-4000K
CRI>90
led cob luminus



Optional features

CCT Range

- 5000K
- 6000K

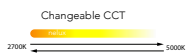

Anti-glare UGR<16



Track head light

Track head light



HOFF



Product description

Hoff track head light series suitable for Hotels, retail shops, coffe-shops, offices, museums, private houses, private clinics. Led colour temperature 2700K, 3000K & 4000K as standards. Made from die-cast aluminum, electrostatic powder coating , reflectors made from aluminum high standards, different angles available. Led drivers khün, osram, philips.

Accessories & options

- Philips, Samsung
- Khün, osram, kegu
- CRI>90 or above
- Dimmable (Triac, 0-10v)
- DALI



Hoff series

TS65108.15 Reflector

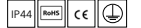

TS65108.15 - Input voltage AC220-240V Multivoltage
15W
~885lm 2700K-3000K-4000K
CRI>80
led cob citizen

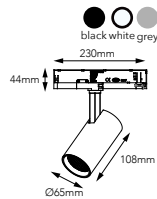

TS75145.25 Reflector

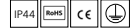

TS75145.20 - Input voltage AC220-240V Multivoltage
25W
~1795lm 2700K-3000K-4000K
CRI>80
led cob citizen

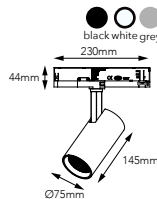

TS85165.35 Reflector



TS85165,30 - Input voltage AC220-240V Multivoltage
35W
~2780lm 2700K-3000K-4000K
CRI>80
led cob citizen

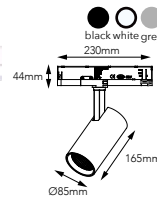

TS6575.08 Lens



TS6575.08 - AC COB
8W
~645lm 2700K-3000K-4000K
CRI>80 CRI>90
led cob citizen

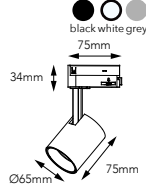

TL7035.08 Lens



TL7035.08 - AC COB
8W
~665lm 2700K-3000K-4000K
CRI>80 CRI>90
led cob luminus

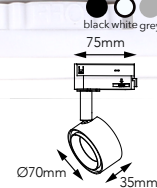

Optional features

CCT Range

- 5000K
- 6000K

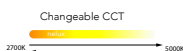

Anti-glare UGR<16



Honey comb



HOFF

HOFF

Track head light

Track head light



HOFF pill



Product description

Hoff track head light series suitable for Hotels, retail shops, coffe-shops, offices, museums, private houses, private clinics. Led colour temperature 2700K, 3000K & 4000K as standards. Made from die-cast aluminum, electrostatic powder coating, reflectors made from aluminum high standards, different angles available. Led drivers khün, osram, philips.

Accessories & options

- Philips, Samsung
- Khün, osram, kegu
- CRI>90 or above
- Dimmable (Triac, 0-10v)
- DALI



Hoff pill series

TS8259.10 Lens



TS8259.10 - Input voltage AC220-240V Multivoltage
10W
~825lm 2700K-3000K-4000K
CRI>90
led cob cree

TS10172.20 Lens



TS10172.20 - Input voltage AC220-240V Multivoltage
20W
~1620lm 2700K-3000K-4000K
CRI>90
led cob cree

TS6080.15 Lens



TS6080.15 - Input voltage AC220-240V Multivoltage
15W
~1435lm 2700K-3000K-4000K
CRI>90
led cob cree

TS72100.25 Lens



TS72100.25 - Input voltage AC220-240V Multivoltage
25W
~1570lm 2700K-3000K-4000K
CRI>90
led cob cree



Optional features

CCT Range

- 2700K
- 3000K
- 4000K

Anti-glare UGR<16

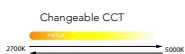

Track head light

Track head light



HOFF ZOOM- CCT- 0-10V



Product description

Hoff zoomer made from aluminium. Track head light series suitable for Hotels, retail shops, coffe-shops, offices, museums, private houses, private clinics. Led colour temperature 2700K, 3000K & 4000K as standards. Made from die-cast aluminium, electrostatic powder coating , reflectors made from aluminum high standards, zoomable 15° to 50°. Led drivers khün, osram, philips. Dimmable 0/1V - 10V

ZOOMER track head light



Accessories & options

- Tonyonia
- Khün, osram, kegu
- CRI>90 or above
- Changeable CCT
- Dimmable (Triac, 0-10v)
- DALI

Hoff series

TS70188.15



TS70188.15 - Input voltage AC220-240V Multivoltage 15W
 ~1125lm from 2700K to 3000K to 4000K changeable
 CRI>80 CRI>90
 led tonyo
Features
 *Isolated non-dimmable driver built in, 1-10V dimmable
 *beam angle changeable 15° to 50°
 *CCT from 2700K to 3000K to 4000K changeable
 *Track connector 4 lines
 *AC100-240V 50/60Hz

TS85194.25



TS85194.25 - Input voltage AC220-240V Multivoltage 25W
 ~1875lm from 2700K to 3000K to 4000K changeable
 CRI>80 CRI>90
 led tonyo
Features
 *Isolated non-dimmable driver built in, 1-10V dimmable
 *beam angle changeable 15° to 50°
 *CCT from 2700K to 3000K to 4000K changeable
 *Track connector 4 lines
 *AC100-240V 50/60Hz

TS85165.25



TS85165.25 - Input voltage AC220-240V Multivoltage 25W
 ~1875lm from 2700K to 3000K to 4000K changeable
 CRI>80 CRI>90
 led citizen
Features
 *Isolated non-dimmable driver built in, 1-10V dimmable
 *beam angle changeable 15° to 50°
 *CCT non-changeable
 *Track connector 4 lines
 *AC100-240V 50/60Hz



Optional features



Power
 The wattage of led track spot light can be 10W, 15w, 20W, 25W, 30W, 35W, 40W, 45W and 55W according to client specifications.

HOFF

HOFF

Track head light

Track head light



VOTI zoom



Product description

VOTI series. TILTABLE & ROTATABLE ZOOMER TRACK LIGHT UL approval . Tracklight series suitable for Hotels, retail shops, coffe-shops, offices, museums, private houses, private clinics. Led colour temperature 2700K, 3000K & 4000K as standards. Made from aluminum, electrostatic powder coating , different angles available. Led drivers khün, osram, philips.

Accessories & options

- Citizen
- Khün, osram, kegu
- CRI>90 or above
- Dimmable (Triac, 0-10v)
- DALI



Voti zoom series

TL60261.15 Zoomer

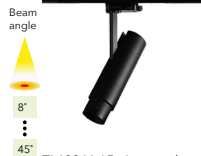

TL60261.15 - Input voltage AC220-240V Multivoltage
15W
~360~530lm 2700K-3000K-4000K
CRI>80
led cob osram

TL76305.30 Zoomer

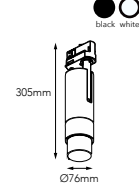

TL76305.30- Input voltage AC220-240V Multivoltage
30W
~1150~2250lm 2700K-3000K-4000K
CRI>80
led cob bridgelux



Optional features

- CCT Range
- 5000K
 - 6000K

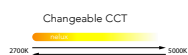

Track head light

Track head light



VOTI



Product description

VOTI series TILTABLE & ROTATABLE TRACK HEAD LIGHT . Tracklight series suitable for Hotels, retail shops, coffe-shops, offices, museums, private houses, private clinics. Led colour temperature 2700K, 3000K & 4000K as standards. Made from aluminum, electrostatic powder coating , different angles available. Led drivers khün, osram, philips. **Long and thing special design**

Accessories & options

- Cree
- Dimmable (Triac, 0-10v)
- Khün, osram, kegu
- DALI
- CRI>90 or above



Voti series

TL40212.08

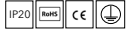

TL40212.08- Input voltage AC220-240V Multivoltage
 8W
 ~358lm 2700K-3000K-4000K
 CRI>80
 led cob bridgelux

Application ideas



Optional features

- CCT Range
- 5000K
- 6000K

Track head light

Track head light



VOTI



Product description

VOTI series. Tracklight suitable for Hotels, retail shops, coffe-shops, offices, museums, private houses, private clinics. Led colour temperature 2700K, 3000K & 4000K as standards. Made from aluminum, electrostatic powder coating, different angles available. Led drivers khün, osram, philips. **Same design different size and power.**

Accessories & options

- Citizen
- Dimmable (Triac, 0-10v)
- Khün, osram, kegu
- DALI
- CRI>90 or above



Voti lens series

TL81213.30 Lens version

IP20 RoHS CE

Beam angle: 8°, 45°

black white

TL81213.30 - Input voltage AC220-240V Multivoltage 30W ~3300 2700K-3000K-4000K CRI>80 led cob evercore

TL76211.20 Lens version

IP20 RoHS CE

Beam angle: 18°, 55°

black white

TL76211.20 - Input voltage AC220-240V Multivoltage 20W ~2050lm 2700K-3000K-4000K CRI>80 led cob bridgelux

TL60165.12 Lens version

IP20 RoHS CE

Beam angle: 20°, 40°, 60°

black white

TL60165.12 - Input voltage AC220-240V Multivoltage 12W ~890lm 2700K-3000K-4000K CRI>80 led cob citizen

Voti Reflector series

TL81241.30 Reflector version

IP20 RoHS CE

Beam angle: 16°, 24°, 40°, 60°

black white

TL81241.30 - Input voltage AC220-240V Multivoltage 30W ~2902lm 2700K-3000K-4000K CRI>80 led cob bridgelux

TL76231.20W Reflector version

IP20 RoHS CE

Beam angle: 15°, 24°, 40°

black white

TL76231.20W - Input voltage AC220-240V Multivoltage 20W ~1901lm 2700K-3000K-4000K CRI>80 led cob bridgelux

TL60175.12 Reflector version

IP20 RoHS CE

Beam angle: 15°, 25°, 38°, 60°

black white

TL60175.12 - Input voltage AC220-240V Multivoltage 12W ~825lm 2700K-3000K-4000K CRI>80 led cob bridgelux



Optional features

CCT Range

- 5000K
- 6000K

Changeable CCT

Dimmable brightness

Reflector or lens

VOTI

VOTI

Track head light

Track head light



VOTI kompak



Product description

VOTI series . Tracklight series suitable for Hotels, retail shops, coffe-shops, offices, museums, private houses, private clinics. Led colour temperature 2700K, 3000K & 4000K as standards. Made from aluminum, electrostatic powder coating , different angles available. Led drivers khün, osram, philips. Integrated adapter driver. **Reflector and lens version**

Accessories & options

- Cree
- Dimmable (Triac, 0-10v)
- Khün, osram, kegu
- DALI
- CRI>90 or above



VOTI kompak series

TL78171.15 Reflector



TL78171.15 - Input voltage AC220-240V Multivoltage
15W
~1406lm 2700K-3000K-4000K
CRI>80
led cob bridgelux



TL89180.30 Reflector



TL89180.30 - Input voltage AC220-240V Multivoltage
30W
~2500lm 2700K-3000K-4000K
CRI>80
led cob citizen



TL8592.30 Lens version



TL8592.30 - Input voltage AC220-240V Multivoltage
30W
~2400lm 2700K-3000K-4000K
CRI>80
led cob citizen



TL7077.18 Lens version



TL7077.18 - Input voltage AC220-240V Multivoltage
18W
~1440lm 2700K-3000K-4000K
CRI>80
led cob bridgelux



TL6067.12 Lens version

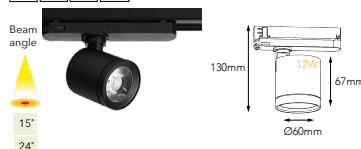

TL6067.12 - Input voltage AC220-240V Multivoltage
12W
~960lm 2700K-3000K-4000K
CRI>80
led cob bridgelux



TL4565.07 Lens version

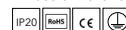

TL4565.07 - Input voltage AC220-240V Multivoltage
7W
~560lm 2700K-3000K-4000K
CRI>80
led cob bridgelux



Optional features

- CCT Range
- 5000K
 - 6000K



VOTI

VOTI

Track head light

Track head light



VOTI kompak



Product description

VOTI series Tracklight series suitable for Hotels, retail shops, coffe-shops, offices, museums, private houses, private clinics. Led colour temperature 2700K, 3000K & 4000K as standards. Made from aluminum, electrostatic powder coating, different angles available. Led drivers khün, osram, philips. Integrated adapter driver.

Accessories & options

- Citizen
- Dimmable (Triac, 0-10v)
- Khün, osram, kegu
- DALI
- CRI>90 or above



VOTI kompak series

TL85170.30 Reflector version



TL85170.30 - Input voltage AC220-240V Multivoltage
30W
~2400lm 2700K-3000K-4000K
CRI>80
led cob bridgelux



TL70153.18 Reflector



TL70153.18 - Input voltage AC220-240V Multivoltage
18W
~1440lm 2700K-3000K-4000K
CRI>80
led cob bridgelux



TL60130.12 Lens version



TL60130.12 - Input voltage AC220-240V Multivoltage
12W
~960lm 2700K-3000K-4000K
CRI>80
led cob citizen



TL45128.07 Reflector version

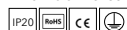

TL45128.07 - Input voltage AC220-240V Multivoltage
7W
~560lm 2700K-3000K-4000K
CRI>80
led cob bridgelux



TL85141.20



TL85141.20 - Input voltage AC220-240V Multivoltage
20W
~1600lm 2700K-3000K-4000K
CRI>80
led cob bridgelux



TL64127.10



TL64127.10 - Input voltage AC220-240V Multivoltage
10W
~800lm 2700K-3000K-4000K
CRI>80
led cob bridgelux



Optional features

- CCT Range
- 5000K
 - 6000K

Reflector or lens

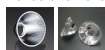

VOTI

VOTI

Track head light

Track head light



VANZO



Product description

VANZO series made from aluminum, electrostatic powder coating. Available power 11W. VANZO series suitable for retail shops, hotels, apartments, private houses, restaurants, private clinics. Led colour temperature 2700K, 3000K & 4000K as standards. , different angles available. Led drivers khün, osram, philips. ip20. **Big range of finished colours.**

Accessories & options

- Citizen
- Dimmable (Triac, 0-10v)
- Khün, osram, kegu
- DALI
- CRI>90 or above

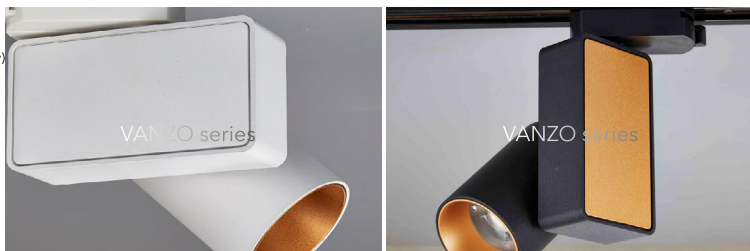

Vanzo series

TS6090.11



Beam angle

18°
24°
36°
60°

TS6090.11 - Input voltage AC220-240V Multivoltage
11W
~900lm - 850lm 2700K-3000K-4000K
CRI>80
led cree cob

TS6090V.11



Beam angle

18°
24°
36°
60°

TS6090V.11 - Input voltage AC220-240V Multivoltage
11W
~900lm - 850lm 2700K-3000K-4000K
CRI>80
led cree cob

Available colours for Vanzo series



Optional features

CCT Range

- 5000K
- 6000K

Changeable CCT

Reflector or lens

Track head light

Track head light



FOSO 10



Product description

FOSO series. Materials Aluminum and PC rings. IP20 Foso track head light suitable for hotels, retail shops, private clinics, museums, can move the product in the desired direction. **Power 10W and 20W available.**

Accessories & options

- Cree cob led
- Khün, osram, kegu
- CRI>90 or above



Foso 10 series

TL60170.10

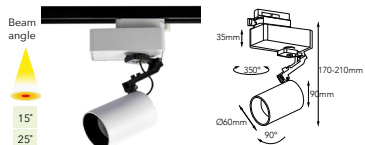

TL60170.10 Input voltage AC220-240V Multivoltage
10W
~840lm 3000K-4000K-5000K
CRI>80
led COB cree

TL85111.20

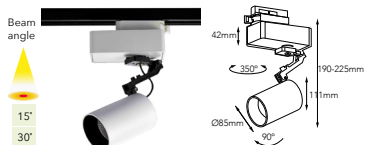

TL85111.20 Input voltage AC220-240V Multivoltage
20W
~1900lm 3000K-4000K-5000K
CRI>80
led COB cree

Ceiling installation with track light

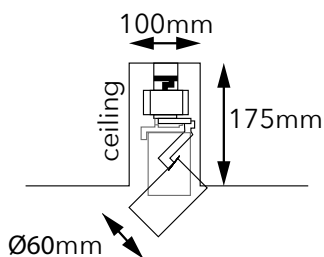

Ceiling installation with track light

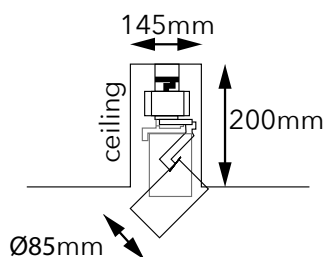

Optional features

- CCT Range
- 5000K
- 6000K

Optional optical components

FOSO

FOSO

Track head light

Track head light



FOSO 20



Product description

FOSO series. Materials Aluminum and PC rings. IP20 Foso track head light suitable for hotels, retail shops, private clinics, museums, can move the product in the desired direction. **Power 20W,28W and 35W available.**

Accessories & options

- Cree cob led
- Khün, osram, kegu
- CRI>90 or above



Foso 20 series

TL70145.20



TL70145.20 Input voltage AC220-240V Multivoltage
20W
~1750lm 3000K-4000K-5000K
CRI>80
led COB cree

TL85160.28



TL85160.28 Input voltage AC220-240V Multivoltage
28W
~2400lm 3000K-4000K-5000K
CRI>80
led COB cree

TL95170.35



TL95170.35 Input voltage AC220-240V Multivoltage
35W
~3400lm 3000K-4000K-5000K
CRI>80
led COB cree

TL85104.20



TL85104.20 Input voltage AC220-240V Multivoltage
20W
~1750lm 3000K-4000K-5000K
CRI>80
led COB cree

TL95112.28



TL95112.28 Input voltage AC220-240V Multivoltage
28W
~1750lm 3000K-4000K-5000K
CRI>80
led COB cree

TL106123.35



TL106123.35 Input voltage AC220-240V Multivoltage
35W
~3500lm 3000K-4000K-5000K
CRI>80
led COB cree



Optional features

- CCT Range
- 5000K
 - 6000K

Optional optical components

Track head light

Track head light

DOWN & TRACK HEAD LIGHT

Upgrade your projects as restaurant, rooms, hotels , private clinics, offices, retail shops, for the chance to enjoy new design with nelux hifen down & track series giving a chic touch.

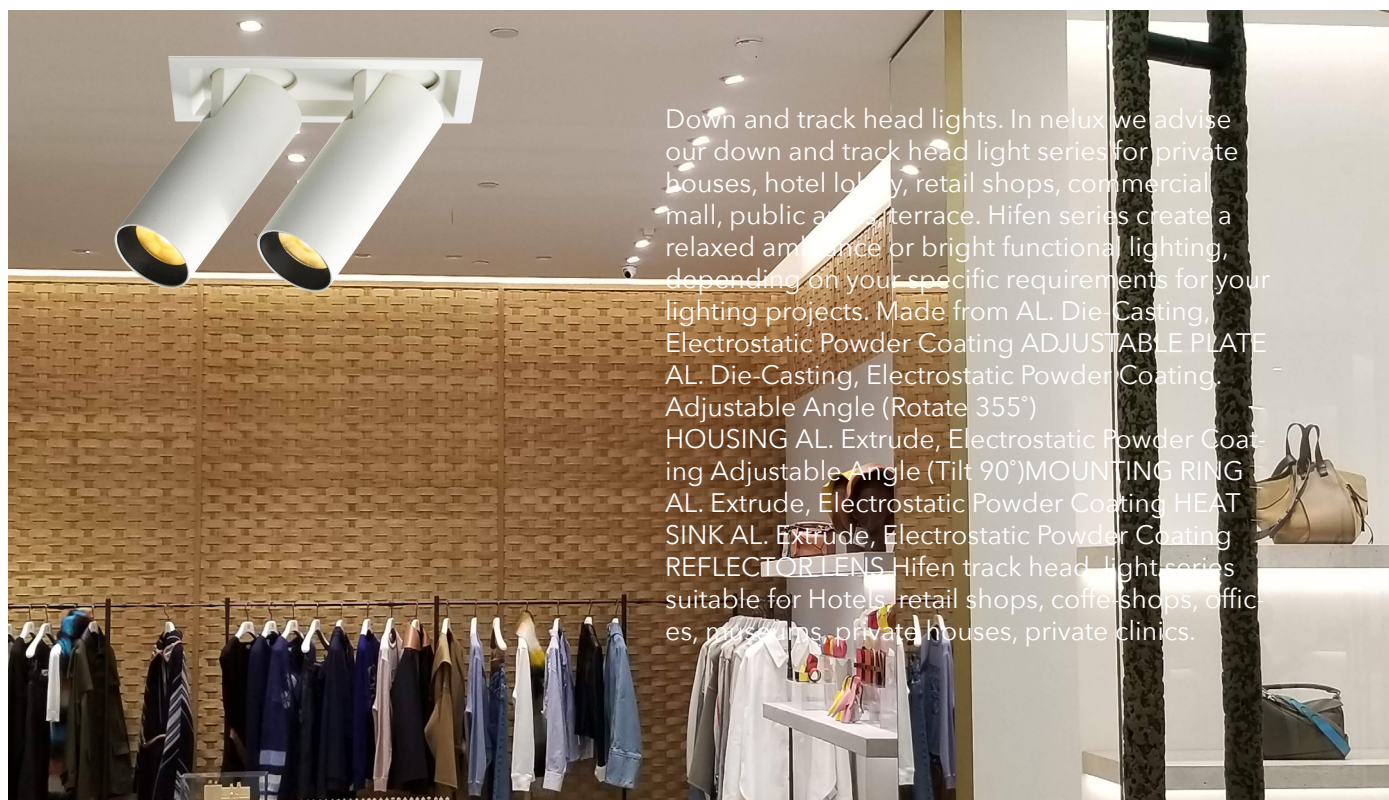

Down and track head lights. In nelux we advise our down and track head light series for private houses, hotel lobby, retail shops, commercial mall, public area, terrace. Hifen series create a relaxed ambience or bright functional lighting, depending on your specific requirements for your lighting projects. Made from AL. Die-Casting, Electrostatic Powder Coating ADJUSTABLE PLATE AL. Die-Casting, Electrostatic Powder Coating. Adjustable Angle (Rotate 355°) HOUSING AL. Extrude, Electrostatic Powder Coating Adjustable Angle (Tilt 90°) MOUNTING RING AL. Extrude, Electrostatic Powder Coating HEAT SINK AL. Extrude, Electrostatic Powder Coating REFLECTOR LENS Hifen track head light series suitable for Hotels, retail shops, coffee shops, offices, museums, private houses, private clinics.

Downlights y proyectores de carril/riel serie Hifen. En nelux aconsejamos nuestra serie Hifen para casas particulares, lobby de hotel, tiendas minoristas, centro comercial, restaurantes, cafeterías, clínicas privadas, condominios. La serie Hifen crea un ambiente relajado y una iluminación funcional brillante para cualquier espacio ofreciendo, diferentes requisitos específicos para sus proyectos de iluminación. Diferentes medidas y potencias disponibles.

nelux architectural lighting



Down and track head lights

In nelux we advise you our down and track head light series for private houses, hotel lobby, retail shops, commercial mall, public areas, terrace. All our series create a relaxed ambiance or bright functional lighting, depending on your specific requirements for your lighting projects.



Down & Track head lights

HIFEN series Ø35



7W



7W



2x7W



7W



7W



2x7W



7W



7W

HIFEN series Ø60



24W



24W



18W



18W

Please remember, you must follow the strict electrical safety regulations of your country and pay attention to IP ratings.



HIFEN series Ø35



Product description

TRIM AL. Die-Casting, Electrostatic Powder Coating ADJUSTABLE PLATE AL. Die-Casting, Electrostatic Powder Coating. Adjustable Angle (Rotate 355°)
HOUSING AL. Extrude, Electrostatic Powder Coating Adjustable Angle (Tilt 90°) MOUNTING RING AL. Extrude, Electrostatic Powder Coating HEAT SINK AL. Extrude, Electrostatic Powder Coating REFLECTOR LENS Hifen track head light series suitable for Hotels, retail shops, coffe-shops, offices, museums, private houses, private clinics.

Accessories & options

- Cree
- Dimmable (Triac, 0-10v)
- Khün, osram, kegu
- DALI
- CRI>90 or above



Hifen series

RL7795 - 7W

IP20

Beam angle: 15°, 24°, 38°

black white grey

Ø77mm, 108mm, Ø35mm, 95mm, Ø65mm

RL7795 - Input voltage AC220-240V Multivoltage 7W ~480lm 2700K-3000K-4000K CRI>80 CRI>90 led cob cree

RL6969S - 7W

IP20

Beam angle: 15°, 24°, 38°

black white grey

69mm, 69mm, 113mm, Ø35mm, 95mm, 65x60mm

RL6969S - Input voltage AC220-240V Multivoltage 7W ~480lm 2700K-3000K-4000K CRI>80 CRI>90 led cob cree

RL69129S - 2x7W

IP20

Beam angle: 15°, 24°, 38°

black white grey

69mm, 129mm, 113mm, Ø35mm, 95mm, 124x60mm

RL69129S - Input voltage AC220-240V Multivoltage 2x7W ~2x480lm 2700K-3000K-4000K CRI>80 CRI>90 led cob cree

RL77165 - 7W

IP20

Beam angle: 15°, 24°, 38°

black white grey

77mm, 180mm, Ø35mm, 165mm, Ø65mm

RL35165 - Input voltage AC220-240V Multivoltage 7W ~480lm 2700K-3000K-4000K CRI>80 CRI>90 led cob cree

RL6969SL 7W

IP20

Beam angle: 12°, 24°, 38°

black white grey

69mm, 69mm, 180mm, Ø35mm, 165mm, 65x60mm

RL6969SL - Input voltage AC220-240V Multivoltage 7W ~480lm 2700K-3000K-4000K CRI>80 CRI>90 led cob cree

RL69129SL - 2x7W

IP20

Beam angle: 15°, 24°, 38°

black white grey

69mm, 129mm, 180mm, Ø35mm, 165mm, 124x60mm

RL69129SL - Input voltage AC220-240V Multivoltage 2x7W ~2x480lm 2700K-3000K-4000K CRI>80 CRI>90 led cob cree

TS9535 - 7W

IP20

Beam angle: 15°, 24°, 38°

355°, 90°, Ø35mm, 95mm

TS9535 - Input voltage AC220-240V Multivoltage 7W ~480lm 2700K-3000K-4000K CRI>80 CRI>90 led cob cree

TS16535 - 7W

IP20

Beam angle: 12°, 24°, 38°

300°, 90°, Ø35mm, 165mm

TS16535 - Input voltage AC220-240V Multivoltage 7W ~480lm 2700K-3000K-4000K CRI>80 CRI>90 led cob cree



Optional features

CCT Range

Changeable CCT: 2700K (warm white) to 5000K (cool white)

Dimmable brightness: 2700K to 5000K

Down & Track head light

Down & Track head light



HIFEN series Ø60



Product description

TRIM AL. Die-Casting, Electrostatic Powder Coating ADJUSTABLE PLATE AL. Die-Casting, Electrostatic Powder Coating. Adjustable Angle (Rotate 355°)
 HOUSING AL. Extrude, Electrostatic Powder Coating Adjustable Angle (Tilt 90°) MOUNTING RING AL. Extrude, Electrostatic Powder Coating HEAT SINK AL. Extrude, Electrostatic Powder Coating REFLECTOR LENS Hifen track head light series suitable for Hotels, retail shops, coffe-shops, offices, museums, private houses, private clinics.

Accessories & options

- Citizen
- Khün, osram, kegu
- CRI>90 or above
- Dimmable (Triac, 0-10v)
- DALI



HIFEN Ø60

HIFEN Ø60

Hifen series

RL13460 - 24W



- Beam angle
- 15°
 - 24°
 - 38°



RL13460 - Input voltage AC220-240V Multivoltage 24W
 ~1920lm 2700K-3000K-4000K
 CRI>80 CRI>90
 led cob cree

TS13460 - 24W



- Beam angle
- 15°
 - 24°
 - 38°

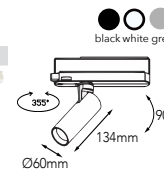

TS13460 - Input voltage AC220-240V Multivoltage 24W
 ~1920lm 2700K-3000K-4000K
 CRI>80 CRI>90
 led cob cree

RL16160 - 18W



- Beam angle
- 15°
 - 24°
 - 38°

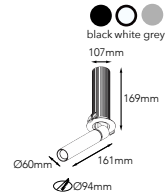

RL16160 - Input voltage AC220-240V Multivoltage 18W
 ~1540lm 2700K-3000K-4000K
 CRI>80 CRI>90
 led cob cree

TS16160 - 18W



- Beam angle
- 15°
 - 24°
 - 38°

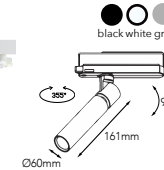

TS16160 - Input voltage AC220-240V Multivoltage 18W
 ~1540lm 2700K-3000K-4000K
 CRI>80 CRI>90
 led cob cree



Optional features

CCT Range

- 5000K
- 6000K

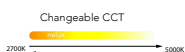

Down & Track head light

Down & Track head light

INLINE LIGHT

Upgrade your projects as restaurant, rooms, hotels , private clinics, offices, retail shops, for the chance to enjoy new design Inline family giving a chic touch.



Our Inline family of products have a big range of possibilities from pendant, surface, track linear light to recessed lighting products. Made from aluminium-die casting and anodized powder coating gives your lighting the top quality.

Nuestra familia de productos Inline tiene una amplia gama de posibilidades desde iluminación colgante, superficie, lineal sobre riel e iluminación empotrada. Fabricados en inyección de zamak y aluminio estos productos dan a sus proyectos de iluminación la diferencia que proporcionan los productos de alta calidad.

nelux architectural lighting



Down and track head lights

In nelux we advise you our down and track head light series for private houses, hotel lobby, retail shops, commercial mall, public areas, terrace. All our series create a relaxed ambiance or bright functional lighting, depending on your specific requirements for your lighting projects.



Inline light

TRACK LINEAR LIGHT Inline series

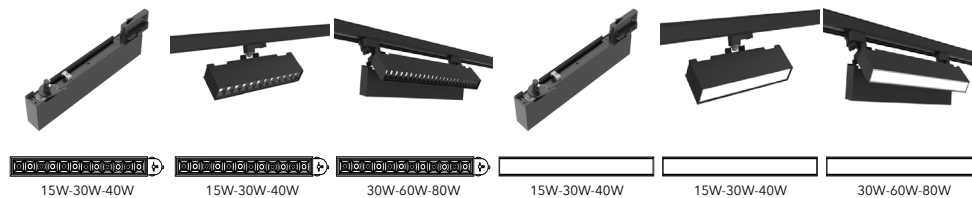

SURFACE LINEAR LIGHT Inline series

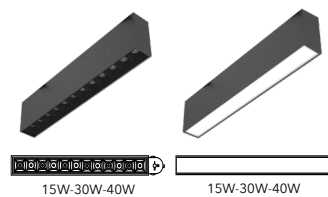

PENDANT LINEAR LIGHT Inline series

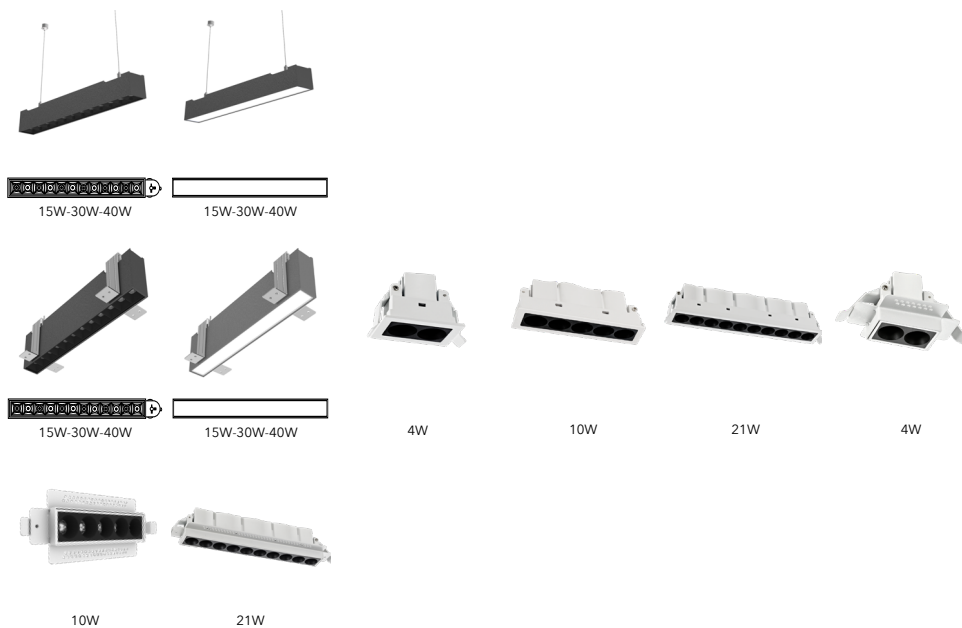

MIRROR TRACK & PENDANT LINEAR LIGHT Inline series

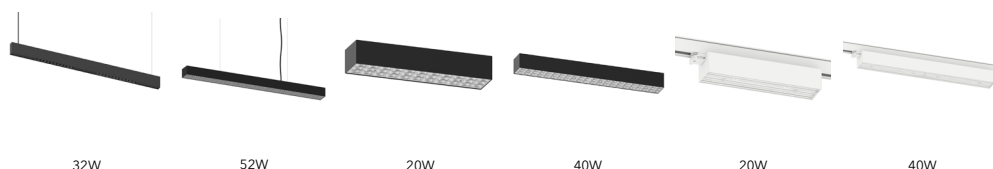

Please remember, you must follow the strict electrical safety regulations of your country and pay attention to IP ratings.



TRACK LINEAR LIGHT Inline



Product description

TRACK LINEAR LIGHT INLINE series, made from extruded aluminium integrated, advanced thermal management technology to ensure consistency of led life span. High transmittance PMMA diffuser or stainless steel reflector creating a high visula comfort and uniform lighting distribution. Light source SMD3030 or SMD2835 ~90lm/w also available 120lm/w CRI>80 as standard. Mounting options: track mounted, surface , recessed and suspended. Applied to Institutes, hospitals, warehouses, hospitality retails, fake ceiling, concealed spaces.

Accessories & options

- Philips,Samsung
- Khün, osram, kegu
- CRI>90 or above
- Dimmable (Triac, 0-10v)
- DALI

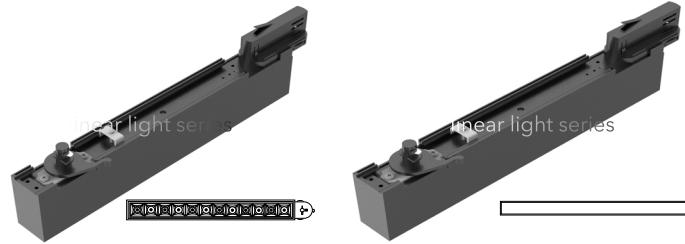

Track linear light Inline series

<p>LLT325L.15</p> <p></p> <p>grey black white</p> <p>Beam angle: 10°, 24°, 38°</p> <p>326.50mm</p> <p>72mm</p> <p>37mm</p> <p>LLT325L.15 - Input voltage AC220-240V Multivoltage 15W ~1400lm - 2700K-3000K-4000K CRI>80 led SMD3030 philips or samsung</p>	<p>LLT645L.30</p> <p></p> <p>grey black white</p> <p>Beam angle: 10°, 24°, 38°</p> <p>644.50mm</p> <p>72mm</p> <p>37mm</p> <p>LLT645L.30 - Input voltage AC220-240V Multivoltage 30W ~2450lm - 2700K-3000K-4000K CRI>80 led SMD3030 philips or samsung</p>	<p>LLT965L.40</p> <p></p> <p>grey black white</p> <p>Beam angle: 10°, 24°, 38°</p> <p>862.50mm</p> <p>72mm</p> <p>37mm</p> <p>LLT965L.40 - Input voltage AC220-240V Multivoltage 40W ~3200lm - 2700K-3000K-4000K CRI>80 led SMD3030 philips or samsung</p>
<p>LLT275PC.15</p> <p></p> <p>grey black white</p> <p>Beam angle: 90°</p> <p>275mm</p> <p>72mm</p> <p>37mm</p> <p>LLT275PC.15 - Input voltage AC220-240V Multivoltage 15W ~1200lm - 2700K-3000K-4000K CRI>80 led SMD3030 philips or samsung</p>	<p>LLT540PC.30</p> <p></p> <p>grey black white</p> <p>Beam angle: 90°</p> <p>540mm</p> <p>72mm</p> <p>37mm</p> <p>LLT540PC.30 - Input voltage AC220-240V Multivoltage 30W ~2400lm - 2700K-3000K-4000K CRI>80 led SMD3030 philips or samsung</p>	<p>LLT1070PC.40</p> <p></p> <p>grey black white</p> <p>Beam angle: 15°, 30°, 45°</p> <p>1070mm</p> <p>72mm</p> <p>37mm</p> <p>LLT1070PC.40 - Input voltage AC220-240V Multivoltage 40W ~3150lm - 2700K-3000K-4000K CRI>80 led SMD3030 philips or samsung</p>

Application ideas





TRACK LINEAR LIGHT Inline



Product description

INLINE LINEAR LIGHT series, made from extruded aluminium integrated, advanced thermal management technology to ensure consistency of led life span. High transmittance PMMA diffuser or stainless steel reflector creating a high visula comfort and uniform lighting distribution. Light source SMD3030 or SMD2835 ~90lm/w also available 120lm/w CRI>80 as standard. Mounting options: track mounted, surface , recessed and suspended. Applied to Institutes, hospitals, warehouses, hospitality retails, fake ceiling, concealed spaces.

Accessories & options

- Philips, Samsung
- Khün, osram, kegu
- CRI>90 or above
- Dimmable (Triac, 0-10v)
- DALI

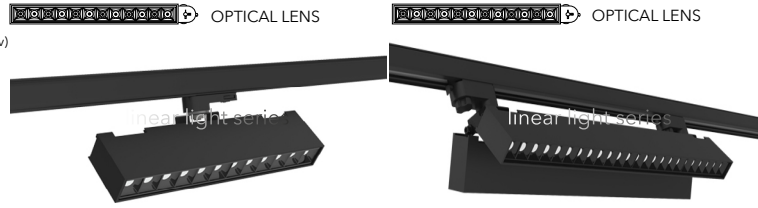

Track linear light Inline series

LLTB325.15 Lens+SMD led

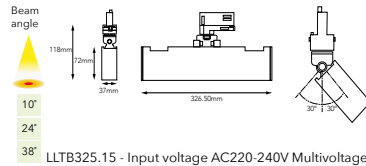

LLTB325.15 - Input voltage AC220-240V Multivoltage
15W
~1400lm - 2700K-3000K-4000K
CRI>80
led SMD3030 philips or samsung

LLTB645.30 Lens+SMD led

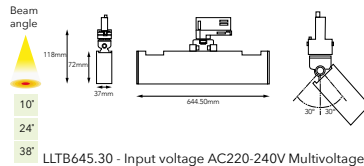

LLTB645.30 - Input voltage AC220-240V Multivoltage
30W
~2450lm - 2700K-3000K-4000K
CRI>80
led SMD3030 philips or samsung

LLTB965.40 Lens+SMD led

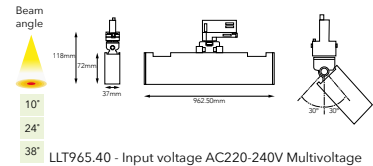

LLTB965.40 - Input voltage AC220-240V Multivoltage
40W
~3200lm - 2700K-3000K-4000K
CRI>80
led SMD3030 philips or samsung

LLTB325-2.30 Lens+SMD led

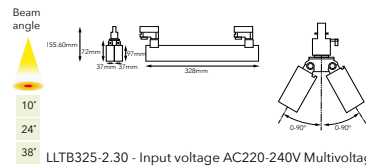

LLTB325-2.30 - Input voltage AC220-240V Multivoltage
30W
~2800lm - 2700K-3000K-4000K
CRI>80
led SMD3030 philips or samsung

LLTB645-2.60 Lens+SMD led

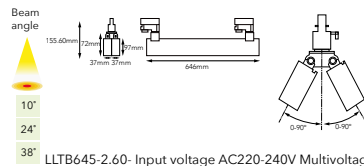

LLTB645-2.60 - Input voltage AC220-240V Multivoltage
60W
~4900lm - 2700K-3000K-4000K
CRI>80
led SMD3030 philips or samsung

LLTB965-2.80 Lens+SMD led

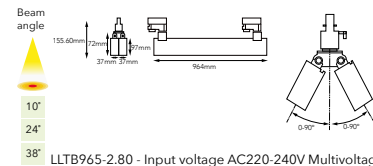

LLTB965-2.80 - Input voltage AC220-240V Multivoltage
80W
~6400lm - 2700K-3000K-4000K
CRI>80
led SMD3030 philips or samsung

Application ideas



INLINE

INLINE



TRACK LINEAR LIGHT Inline



Product description

INLINE LINEAR LIGHT series, made from extruded aluminium integrated, advanced thermal management technology to ensure consistency of led life span. High transmittance PMMA diffuser or stainless steel reflector creating a high visula comfort and uniform lighting distribution. Light source SMD3030 or SMD2835 ~90lm/w also available 120lm/w CRI>80 as standard. Mounting options: track mounted, surface , recessed and suspended. Applied to Institutes, hospitals, warehouses, hospitality retails, fake ceiling, concealed spaces.

Accessories & options

- Philips, Samsung
- Khün, osram, kegu
- CRI>90 or above
- Dimmable (Triac, 0-10v)
- DALI

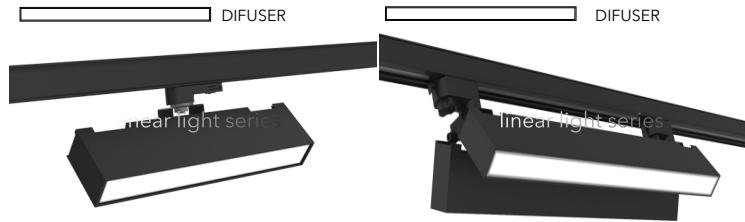

TRACK LINEAR LIGHT

TRACK LINEAR LIGHT

Track linear light Inline series

LLTB325.15 Diffuser+SMD led

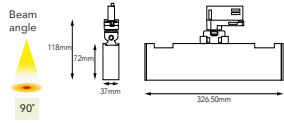

LLTB325.15 - Input voltage AC220-240V Multivoltage
15W
~1200lm - 2700K-3000K-4000K
CRI>80
led SMD2835 philips or samsung

LLTB645.30 Diffuser+SMD led

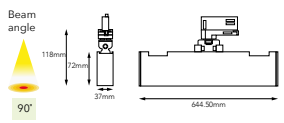

LLTB645.30 - Input voltage AC220-240V Multivoltage
30W
~2300lm - 2700K-3000K-4000K
CRI>80
led SMD2835 philips or samsung

LLTB965.40 Diffuser+SMD led

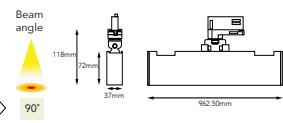

LLTB965.40 - Input voltage AC220-240V Multivoltage
40W
~3150lm - 2700K-3000K-4000K
CRI>80
led SMD2835 philips or samsung

LLTB325-2.30 Diffuser+SMD led

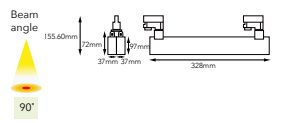

LLTB325-2.30 - Input voltage AC220-240V Multivoltage
30W
~2400lm - 2700K-3000K-4000K
CRI>80
led SMD3030 philips or samsung

LLTB645-2.60 Diffuser+SMD led

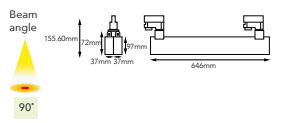

LLTB645-2.60 - Input voltage AC220-240V Multivoltage
60W
~4600lm - 2700K-3000K-4000K
CRI>80
led SMD3030 philips or samsung

LLTB965-2.80 Diffuser+SMD led

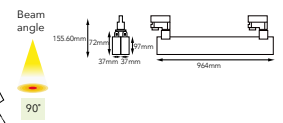

LLTB965-2.80 - Input voltage AC220-240V Multivoltage
80W
~6300lm - 2700K-3000K-4000K
CRI>80
led SMD3030 philips or samsung

Application ideas



INLINE

INLINE



SURFACE LINEAR LIGHT Inline



Product description

SURFACE LINEAR LIGHT INLINE series, made from extruded aluminium integrated, advanced thermal management technology to ensure consistency of led life span. High transmittance PMMA diffuser or stainless steel reflector creating a high visula comfort and uniform lighting distribution. Light source SMD3030 or SMD2835 ~90lm/w also available 120lm/w CRI>80 as standard. Mounting options: track mounted, surface , recessed and suspended. Applied to Institutes, hospitals, warehouses, hospitality retails, fake ceiling, concealed spaces.

Accessories & options

- Philips, Samsung
- Khün, osram, kegu
- CRI>90 or above
- Dimmable (Triac, 0-10v)
- DALI



linear light series



OPTICAL LENS

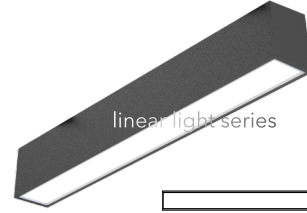

linear light series



DIFUSER

Surface linear light Inline series

LLT325S.15 Optical lens + SMD led

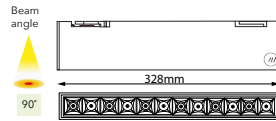

LLTB325S.15 - Input voltage AC220-240V Multivoltage
15W
~1200lm - 2700K-3000K-4000K
CRI>80
led SMD3030 philips

LLTB645S.30 Optical lens + SMD led

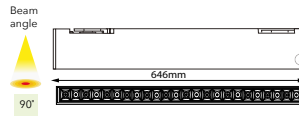

LLTB645S.30 - Input voltage AC220-240V Multivoltage
30W
~2300lm - 2700K-3000K-4000K
CRI>80
led SMD3030 philips

LLTB965S.40 Optical lens + SMD led

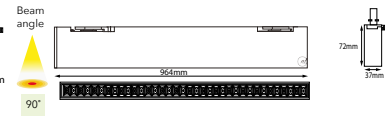

LLT965S.40 - Input voltage AC220-240V Multivoltage
40W
~3150lm - 2700K-3000K-4000K
CRI>80
led SMD3030 philips

LLT325S.15PC Diffuser+SMD led

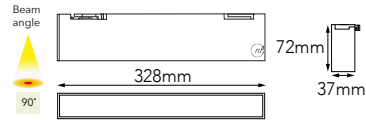

LLT325S.15PC - Input voltage AC220-240V Multivoltage
15W
~1200lm - 2700K-3000K-4000K
CRI>80
led SMD2835 philips

LLTB645S.30PC Diffuser+SMD led

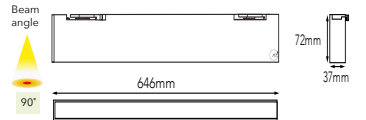

LLTB645S.30PC - Input voltage AC220-240V Multivoltage
30W
~2300lm - 2700K-3000K-4000K
CRI>80
led SMD2835 philips

LLT965S.40PC Diffuser+SMD led

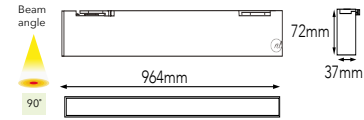

LLT965S.40PC - Input voltage AC220-240V Multivoltage
40W
~3150lm - 2700K-3000K-4000K
CRI>80
led SMD2835 philips

Application ideas



INLINE

INLINE

Product description

PENDANT LINEAR LIGHT INLINE series, made from extruded aluminium integrated, advanced thermal management technology to ensure consistency of led life span. High transmittance PMMA diffuser or stainless steel reflector creating a high visula comfort and uniform lighting distribution. Light source SMD3030 or SMD2835 ~90lm/w also available 120lm/w CRI>80 as standard. Mounting options: track mounted, surface , recessed and suspended. Applied to Institutes, hospitals, warehouses, hospitality retails, fake ceiling, concealed spaces.

Accessories & options

- Philips, Samsung
- Khün, osram, kegu
- CRI>90 or above
- Dimmable (Triac, 0-10v)
- DALI

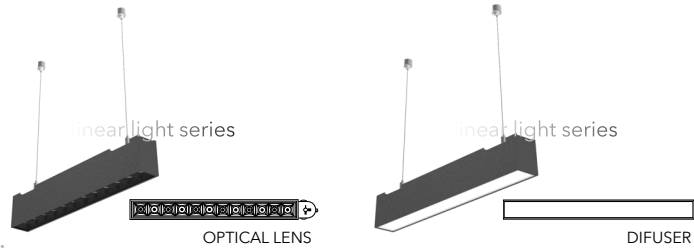

Pendant linear light Inline series

LL328P.15 Optical lens + SMD led

IP20

grey black white

Beam angle: 10°, 24°, 38°

LL328P.15 - Input voltage AC220-240V Multivoltage
15W
~1400lm - 2700K-3000K-4000K
CRI>80
led SMD3030 philips

LL646P.30 Optical lens + SMD led

IP20

grey black white

Beam angle: 10°, 24°, 38°

LL646P.30- Input voltage AC220-240V Multivoltage
30W
~2450lm - 2700K-3000K-4000K
CRI>80
led SMD3030 philips

LL964P.40 Optical lens + SMD led

IP20

grey black white

Beam angle: 10°, 24°, 38°

LL964P.40 - Input voltage AC220-240V Multivoltage
40W
~3200lm - 2700K-3000K-4000K
CRI>80
led SMD3030 philips

LL328P.15PC Diffuser+SMD led

IP20

grey black white

Beam angle: 90°

LL328P.15PC - Input voltage AC220-240V Multivoltage
15W
~1200lm - 2700K-3000K-4000K
CRI>80
led SMD2835 philips

LL646P.30PC Diffuser+SMD led

IP20

grey black white

Beam angle: 90°

LL646P.30PC - Input voltage AC220-240V Multivoltage
30W
~2300lm - 2700K-3000K-4000K
CRI>80
led SMD2835 philips

LL964P.40PC Diffuser+SMD led

IP20

grey black white

Beam angle: 90°

LL964P.40PC - Input voltage AC220-240V Multivoltage
40W
~3150lm - 2700K-3000K-4000K
CRI>80
led SMD2835 philips

Application ideas





RECESSED LINEAR LIGHT Inline



Product description

RECESSED LINEAR LIGHT INLINE series, made from extruded aluminium integrated, advanced thermal management technology to ensure consistency of led life span. High transmittance PMMA diffuser or stainless steel reflector creating a high visula comfort and uniform lighting distribution. Light source SMD3030 or SMD2835 ~90lm/w also available 120lm/w CRI>80 as standard. Mounting options: track mounted, surface , recessed and suspended. Applied to Institutes, hospitals, warehouses, hospitality retails, fake ceiling, concealed spaces.

Accessories & options

- Philips, Samsung
- Khün, osram, kegu
- CRI>90 or above
- Dimmable (Triac, 0-10v)
- DALI

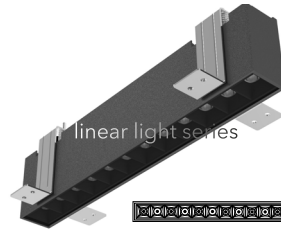

OPTICAL LENS

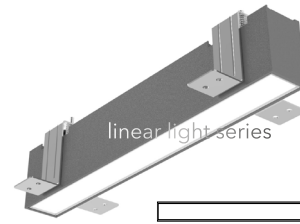

DIFUSER

Recessed linear light Inline series

LLT325S.15 Optical lens + SMD led

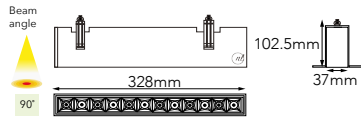

LLT325S.15 - Input voltage AC220-240V Multivoltage
15W
~1200lm - 2700K-3000K-4000K
CRI>80
led SMD3030 philips

LLTB645S.30 Optical lens + SMD led

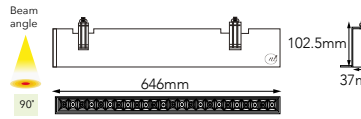

LLTB645S.30 - Input voltage AC220-240V Multivoltage
30W
~2300lm - 2700K-3000K-4000K
CRI>80
led SMD3030 philips

LLTB965S.40 Optical lens + SMD led

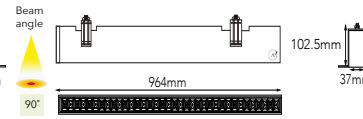

LLT965S.40 - Input voltage AC220-240V Multivoltage
40W
~3150lm - 2700K-3000K-4000K
CRI>80
led SMD3030 philips

LLT325S.15PC Diffuser+SMD led

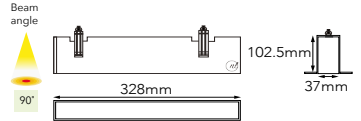

LLT325S.15PC - Input voltage AC220-240V Multivoltage
15W
~1200lm - 2700K-3000K-4000K
CRI>80
led SMD2835 philips

LLTB645S.30PC Diffuser+SMD led

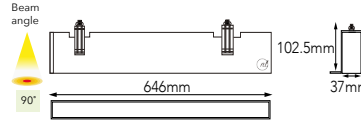

LLTB645S.30PC - Input voltage AC220-240V Multivoltage
30W
~2300lm - 2700K-3000K-4000K
CRI>80
led SMD2835 philips

LLT965S.40PC Diffuser+SMD led

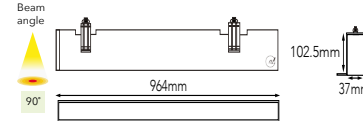

LLT965S.40PC - Input voltage AC220-240V Multivoltage
40W
~3150lm - 2700K-3000K-4000K
CRI>80
led SMD2835 philips

Application ideas

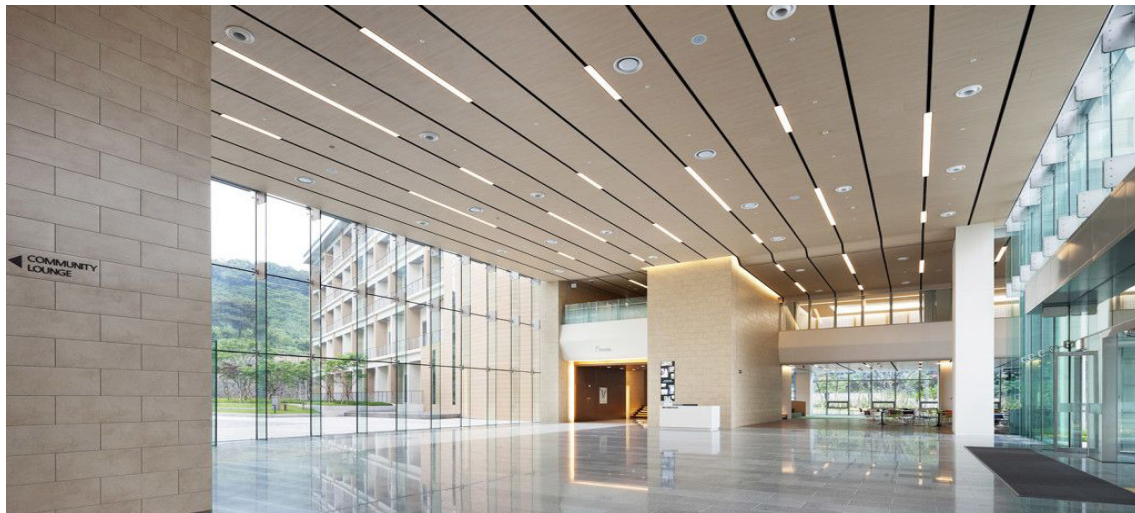

RECESSED LINEAR

RECESSED LINEAR

INLINE

INLINE



TRACK & PENDANT LINEAR LIGHT Inline



Product description

TRACK & PENDANT INLINE made from aluminum. Different beam angles available for your special lighting projects. Applied to hotels, retail shops, restaurants, private clinics, private houses,apartments, different areas to enhance your lighting projects. Led colour temperature 3000K & 4000K as standards.

Accessories & options

- Led Osram
- Dimmable (Triac, 0-10v)
- Khün, osram, kegu
- DALI
- CRI>90 or above

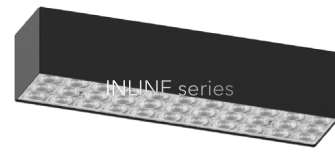

Track & Pendant linear light Inline series

IL3390.32 Suspended linear light

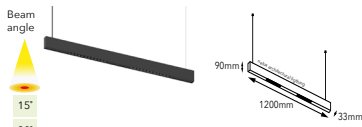
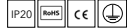

IL3390.32 - Input voltage AC220-240V Multivoltage
32W
~3200lm - 3000K-4000K
CRI>80
led Osram

IL6652.52 Suspended linear light



IL6652.52 - Input voltage AC220-240V Multivoltage
52W
~5800lm - 3000K-4000K
CRI>80
led Bridgelux

IL6652S.20 Surface linear light



IL6652S.20 - Input voltage AC220-240V Multivoltage
20W
~2100lm - 3000K-4000K
CRI>80
led Bridgelux

IL6652S.40 Surface linear light



IL6652S.40 - Input voltage AC220-240V Multivoltage
40W
~4350lm - 3000K-4000K
CRI>80
led Bridgelux

IL6652T.20 Track linear light



IL6652T.20 - Input voltage AC220-240V Multivoltage
20W
~2100lm - 3000K-4000K
CRI>80
led Bridgelux
Beam angle 20x76 / 70x100

IL6652T.40 Track linear light



IL6652T.40 - Input voltage AC220-240V Multivoltage
40W
~4350lm - 3000K-4000K
CRI>80
led Bridgelux
Beam angle 20x76 / 70x100

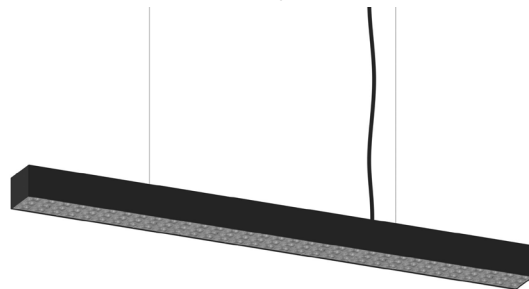

TRACK & PENDANT

TRACK & PENDANT

INLINE

INLINE



RECESSED LINEAR LIGHT Inline Round



Product description

INLINE round series, LINEAR LIGHT line made from aluminum die casting. Different beam angles available for your special lighting projects. Applied to hotels, retail shops, restaurants, private clinics, private houses, apartments, different areas to enhance your lighting projects. Led colour temperature 3000K & 4000K as standards. Trim and trim-less model. Made from aluminum, electrostatic powder coating, reflectors made from PMMA, different angles available.

Accessories & options

- Led Osram, Cree
- Dimmable (Triac, 0-10v)
- CRI>90 or above
- DALI
- Khün, osram, kegu
- Dim to warm



Recessed linear light Inline series

IL6542.04 Recessed linear light



IL6542.04 - Input voltage AC220-240V Multivoltage
4W
~197lm - 2700K-3000K-4000K
CRI>90
led Cree

IL13542.10 Recessed linear light



IL13542.10 - Input voltage AC220-240V Multivoltage
10W
~505lm - 2700K-3000K-4000K
CRI>90
led Cree

IL25542.21 Recessed linear light



IL25542.21 - Input voltage AC220-240V Multivoltage
21W
~1060lm - 2700K-3000K-4000K
CRI>90
led Cree

IL9271.04 Recessed linear light TRIM-LESS



IL9271.04 - Input voltage AC220-240V Multivoltage
4W
~197lm - 2700K-3000K-4000K
CRI>90
led Cree

IL16471.10 Recessed linear light TRIM-LESS

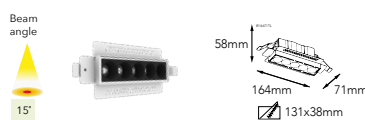

IL16471.10 - Input voltage AC220-240V Multivoltage
10W
~505lm - 2700K-3000K-4000K
CRI>90
led Cree

IL25542.21 Recessed linear light TRIM-LESS

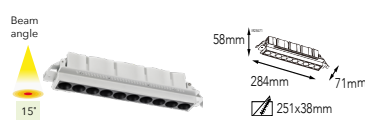
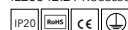

IL25542.21 - Input voltage AC220-240V Multivoltage
21W
~1060lm - 2700K-3000K-4000K
CRI>90
led Cree

Application ideas

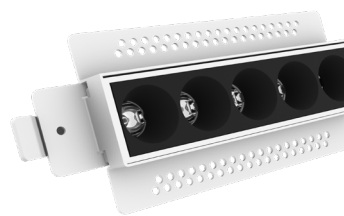
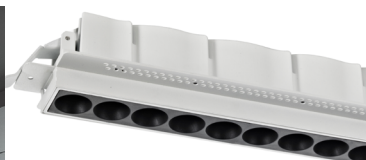

Optional features

CCT Range

- 5000K
- 6000K

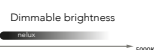
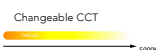

PENDANT LIGHT

Upgrade your projects as restaurant, rooms, hotels , private clinics, offices, retail shops, for the chance to enjoy new design nelux pendant light giving a chic touch.

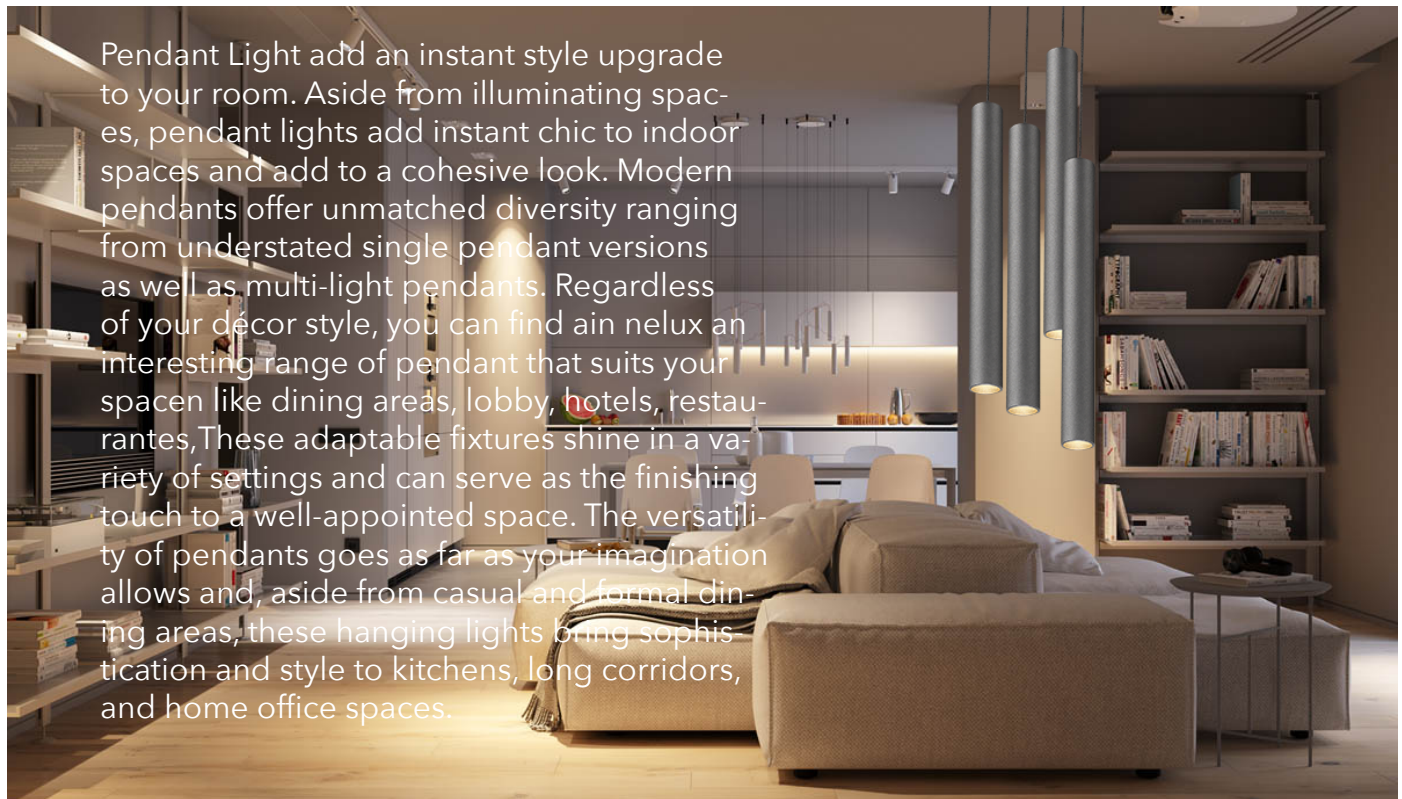

Pendant Light add an instant style upgrade to your room. Aside from illuminating spaces, pendant lights add instant chic to indoor spaces and add to a cohesive look. Modern pendants offer unmatched diversity ranging from understated single pendant versions as well as multi-light pendants. Regardless of your décor style, you can find in nelux an interesting range of pendant that suits your space like dining areas, lobby, hotels, restaurants, These adaptable fixtures shine in a variety of settings and can serve as the finishing touch to a well-appointed space. The versatility of pendants goes as far as your imagination allows and, aside from casual and formal dining areas, these hanging lights bring sophistication and style to kitchens, long corridors, and home office spaces.

La luz colgante además de iluminar espacios, las luces colgantes añaden elegancia instantánea a los espacios interiores y añaden un aspecto cohesivo. Los colgantes modernos ofrecen una diversidad inigualable que va desde versiones sencillas de un colgante hasta colgantes con varias luces.

Independientemente de su estilo de decoración, puede encontrar en nelux una interesante gama de colgantes que se adapten a su espacio, como áreas de comedor, lobby, hoteles, restaurantes, tiendas.

Estos productos destacan en una variedad de entornos y pueden servir como el toque final a un determinado espacio designado. La versatilidad de los colgantes llega tan lejos como la imaginación de los lighting designers, además estas luces colgantes proporcionan sofisticación, estilo y clase a su proyecto.

nelux architectural lighting



Down and track head lights

In nelux we advise you our down and track head light series for private houses, hotel lobby, retail shops, commercial mall, public areas, terrace. All our series create a relaxed ambiance or bright functional lighting, depending on your specific requirements for your lighting projects.



Pendant light

CAMPI series



FIDI series

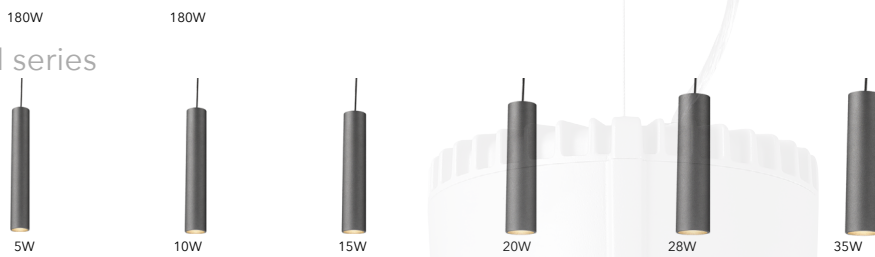

DECORE series



BLO series



Please remember, you must follow the strict electrical safety regulations of your country and pay attention to IP ratings.



CAMPI



Product description

CAMPI series .GEAR BOX AL. Die-Casting, Electrostatic Powder Coating. Wire STS / PVC. SHADES Different type SHADE PC TRIM RING AL. Spinning Processing, Electrostatic Powder SHADE AL. Spinning Processing, Electrostatic Powder Coating. REFLECTOR AL. Anodized Specular Silver. Applied to Institutes, hospitals, warehouses, hospitality retails, concealed spaces.

Accessories & options

- Epistar SMD, cob
- Dimmable (Triac, 0-10v)
- Khün, osram, Philips
- DALI
- CRI>90 or above



Campi series

HB325369.40 shade PC



Beam angle
50°

HB325369.40 - Input voltage AC220-240V MultiV
COB 40W | SMD41
~4214lm | ~3134lm 3000K
CRI>80
led citizen cob, led SMD2835
SHADE PC
TRIM RING AL. Spinning Processing, Electrostatic Powder Coating

HB336361.40 shade AL



Beam angle
40°

HB336361.40 - Input voltage AC220-240V MultiV
COB 40W | SMD41
~4214lm | ~3134lm 3000K
CRI>80
led citizen cob, led SMD2835
SHADE AL. Spinning Processing, Electrostatic Powder Coating
REFLECTOR AL. Anodized Specular Silver

HB413457.96 shade PC



Beam angle
28°
33°
51°

HB413457.96 - Input voltage AC220-240V MultiV
COB 96W
~11215lm 3000K
CRI>80
led citizen cob
SHADE PC

HB426456.96 shade AL

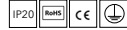

Beam angle
28°
33°
44°

HB426456.96 - Input voltage AC220-240V MultiV
96W
~11230lm 3000K
CRI>80
led citizen cob
SHADE AL. Spinning Processing, Electrostatic Powder Coating

HB32095.90 shade PC



Beam angle
90°

HB32095.90 - Input voltage AC220-240V MultiV
90W
~9311lm 2700K-3000K-4000K
CRI>80
led SMD (130 led)
SHADE PC

HB320135.90 shade AL



Beam angle
90°

WW98108S-TL.13 - Input voltage AC220-240V MultiV
90W
~9937lm 2700K-3000K-4000K
CRI>80
led SMD (130 led)
SHADE AL. Spinning Processing, Electrostatic Powder Coating

HB450105.180 shade PC



Beam angle
90°

HB450105.180 - Input voltage AC220-240V MultiV
180W
~19185lm 3000K-4000K-5700K
CRI>80
led SMD (270 led)
SHADE PC

HB450145.180 shade AL



Beam angle
90°

HB450145.180 - Input voltage AC220-240V MultiV
180W
~18616lm 3000K-4000K-5700K
CRI>80
led SMD (270 led)
SHADE AL. Spinning Processing, Electrostatic Powder Coating



Optional features

CCT Range

2700K

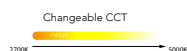

Dimmable brightness



CAMPI

CAMPI

Pendant light

Pendant light



FIDI



Product description

FIDI deco series, made from aluminum die casting. Different beam angles available for your special lighting projects. Applied to hotels, retail shops, private clinics, private houses,apartments, different areas to enhance your lighting projects. Led colour temperature 3000K & 4000K as standards.

Accessories & options

- Philips, Samsung
- Khün, osram, kegu
- CRI>90 or above
- Dimmable (Triac, 0-10v)
- DALI



Fidi series

FD30400.05

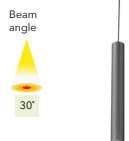

FD30400.05 - Input voltage AC220-240V Multivoltage
5W
~430lm - 3000K-4000K
CRI>80
led cree

FD45300.10

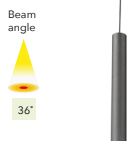

FD45300.10- Input voltage AC220-240V Multivoltage
10W
~850lm - 3000K-4000K
CRI>80
led cree

FD60300.15

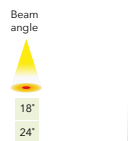

FD60300.15- Input voltage AC220-240V Multivoltage
15W
~1050lm - 3000K-4000K
CRI>80
led cob cree

FD71300.20

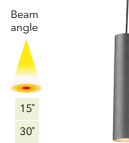

FD71300.20 - Input voltage AC220-240V Multivoltage
20W
~1750lm 3000K-4000K
CRI>80
led smd samsung

FD85220.28

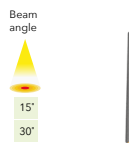

FD85220.28- Input voltage AC220-240V Multivoltage
28W
~2400lm 3000K-4000K
CRI>80
led smd samsung

FD95240.35

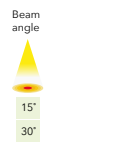

FD95240.35 - Input voltage AC220-240V Multivoltage
35W
~3400lm 3000K-4000K
CRI>80
led smd samsung

Application ideas

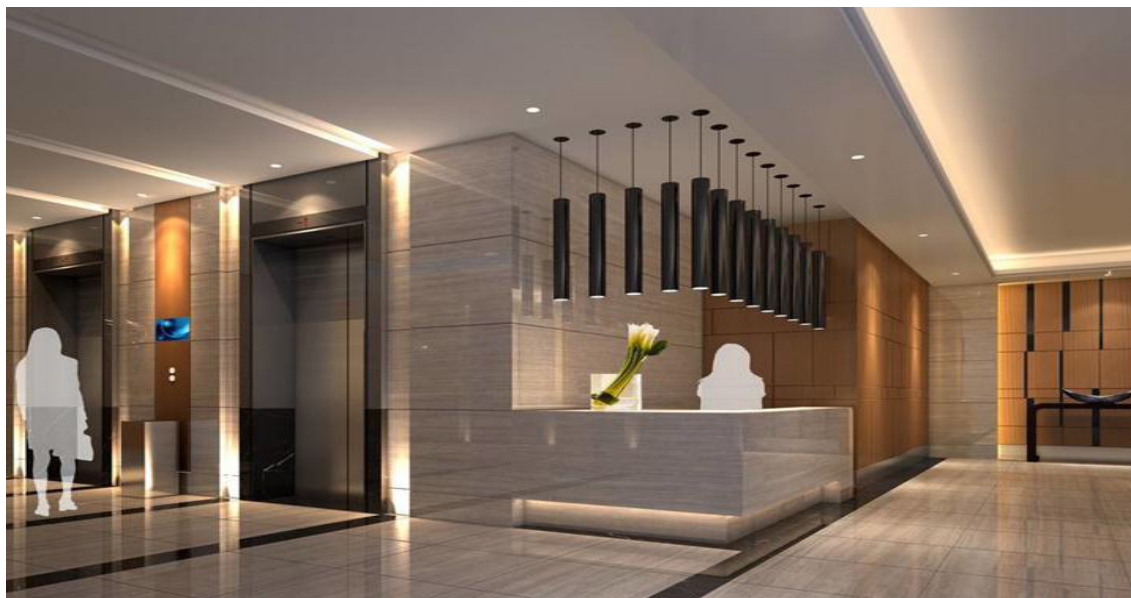



DECORE



Product description

DECORE series, made from aluminum. Different beam angles available for your special lighting projects. Applied to hotels, retail shops, private clinics, private houses, apartments, different areas to enhance your lighting projects.

Accessories & options

- Philips, Samsung
- Khün, osram, kegu
- CRI > 90 or above
- Dimmable (Triac, 0-10v)
- DALI



Decore series

ND111155.12

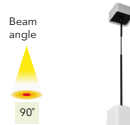

ND111155.12 - Input voltage AC220-240V Multivoltage
12W
~840lm - 3000K-4000K
CRI > 80
led Osram SMT

ND260206.25

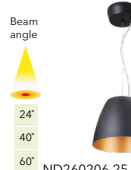

ND260206.25 - Input voltage AC220-240V Multivoltage
25W
~2400lm - 3000K-4000K
CRI > 80
led Cree cob

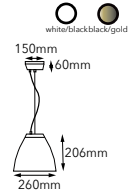

Application ideas



Pendant light

Pendant light

CARDAN - MULTIPLE LIGHT

Upgrade your projects as restaurant, rooms, hotels , private clinics, offices, retail shops, for the chance to enjoy new design nelux cardan-multiple light giving a chic touch to your lighting projects



Cardan multiple light, Multi-directional cardan lighting systems. The modular design makes the CARDAN multiple light downlight and recessed light the ideal choice for many uses. Nelux has a wide range of shapes, sizes, wattages, CCT and finishes to meet the needs of your lighting projects. In turn, the reflectors, with their different finishes provide precision, quality and design and guarantee adequate and bright relief lighting. We have different beam angles to adapt to your needs. More variety of products in our 2020 catalog. Request it.

Sistemas cardan de iluminación multiorientables, el diseño modular convierte a la luz descendente y empotrable CARDAN multiple light en la opción ideal para muchos usos.

Nelux dispone de una amplia gama de formas, tamaños, potencias, CCT y acabados para satisfacer las necesidades en sus proyectos de iluminación. A su vez, los reflectantes con sus diferentes acabados otorgan precisión calidad y diseño y, garantizan una iluminación de relieve adecuada y brillante.

Disponemos de diferentes ángulos de apertura para adaptar a sus necesidades. Más variedad de productos en nuestro catálogo 2020. Solicítelo.



WINDOW



Product description

Cardan multiple light, Multi-directional cardan lighting systems. The modular design makes the CARDAN multiple light downlight and recessed light the ideal choice for many uses. Hotels, Retail shops, restaurants, offices, are the right choice for these fixtures. Window series is an avant-garde product with new design, multiple reflectors and available for different lighting projects, with different power to your choice.

Accessories & options

- Cree, Citizen
- Dimmable (Triac, 0-10v)
- Khün, osram, kegu
- DALI
- CRI>90 or above

Big range of reflectors available



Window series

KR90166.072



Beam angle
15°
24°
36°

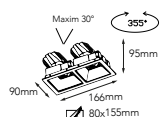

KR90166.07 - Input voltage AC220-240V Multivoltage
7Wx2
~1100lm - 3000K-4000K
CRI>90
led cree

KR90244.073



Beam angle
15°
24°
36°

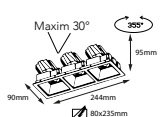
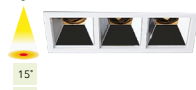

KR90244.073 - Input voltage AC220-240V Multivoltage
7Wx3
~1650lm - 3000K-4000K
CRI>90
led cree

KR113211.122



Beam angle
15°
24°
36°

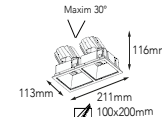
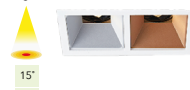

KR113211.122 - Input voltage AC220-240V MultV
12Wx2
~2000lm - 3000K-4000K
CRI>90
led cree

KR113311.123



Beam angle
15°
24°
36°

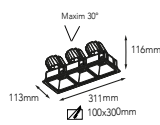
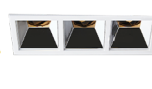

KR113311.123 - Input voltage AC220-240V Multivoltage
12Wx3
~3000lm 3000K-4000K
CRI>90
led cree

KR113211.182



Beam angle
15°
24°
36°

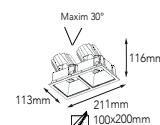
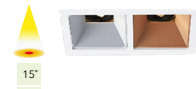

KR113211.122 - Input voltage AC220-240V MultV
18Wx2
~3200lm - 3000K-4000K
CRI>90
led cree

KR113311.183



Beam angle
15°
24°
36°

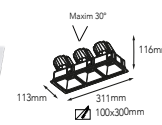

KR113311.123 - Input voltage AC220-240V Multivoltage
18Wx3
~4800lm 3000K-4000K
CRI>90
led cree

Application ideas



Cardan

Cardan

PROFILE LIGHT

Upgrade your projects as restaurant, rooms, hotels , private clinics, offices, retail shops, for the chance to enjoy new design giving a chic touch.

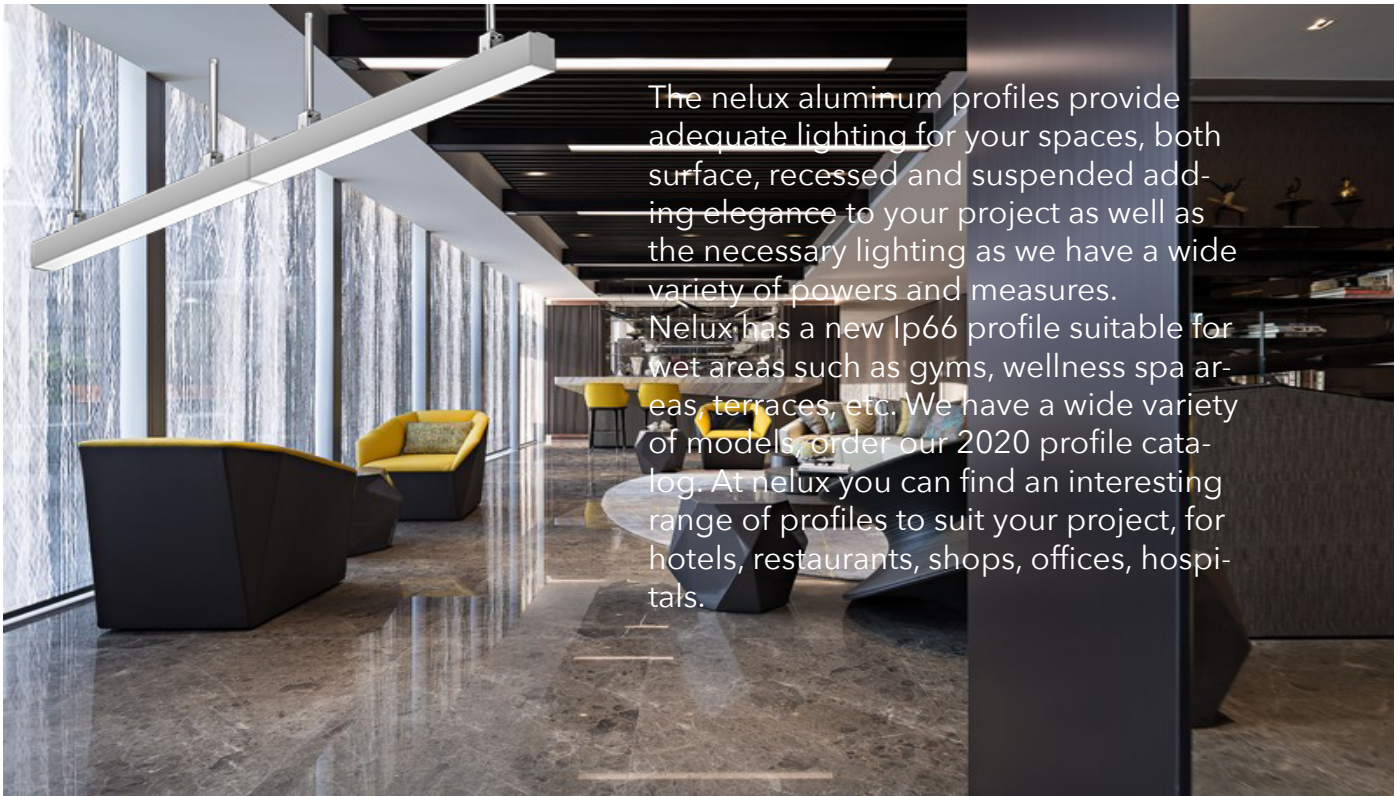

The nelux aluminum profiles provide adequate lighting for your spaces, both surface, recessed and suspended adding elegance to your project as well as the necessary lighting as we have a wide variety of powers and measures. Nelux has a new Ip66 profile suitable for wet areas such as gyms, wellness spa areas, terraces, etc. We have a wide variety of models, order our 2020 profile catalog. At nelux you can find an interesting range of profiles to suit your project, for hotels, restaurants, shops, offices, hospitals.

Los perfiles de aluminio nelux proporcionan la iluminación adecuada para sus espacios, tanto en superficie , empotrados como suspendidos añaden elegancia a su proyecto así como la iluminación necesaria pues disponemos de una gran variedad de potencias y medidas.

Nelux dispone de un nuevo perfil en Ip66 adecuado para zonas húmedas como gimnasios, wellness zonas spa, terrazas, etc. Disponemos de una gran variedad de modelos , solicite nuestro catálogo de perfiles 2020. En nelux puede encontrar una interesante gama de perfiles que se adapten a su proyecto, para hoteles, restaurantes, tiendas, oficinas, hospitales.



PROFILE W34H100



Product description

High quality aluminum alloy lamp body, can be matched with different optical systems (large angle and polarized lens and various angles of light cups). This product is the perfect choice for your lighting projects: office, conference room, study room, public buildings, libraries,...



W34H100 series

Accessories & options

- Cree, Citizen
- Dimmable (Triac, 0-10v)
- Khün, osram, kegu
- DALI
- CRI > 90 or above

Profile W34H100 Cup series

PF34100 Direct light distribution

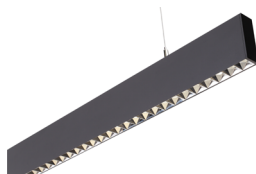
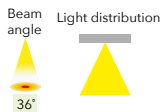

● grey ● black ○ white
3000K-4000K-6000K

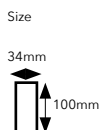

PF34100 - Input voltage AC220-240V Multivoltage

Length	Input Power	Lm/W	Beam angle	Luminous flux	CRI
1126mm	28W	106lm/W	36°	2960lm	80
2239mm	60W	106lm/W	36°	5920lm	80

PF34100 Double sided light distribution

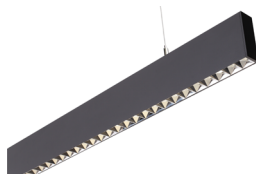
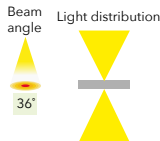

● grey ● black ○ white
3000K-4000K-6000K

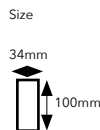

PF34100 - Input voltage AC220-240V Multivoltage

Length	Input Power	Lm/W	Beam angle	Luminous flux	CRI
1126mm	40W	Up110lm/Down106lm/W	36°	Up2000/Down 2120lm	80
2239mm	60W	Up110lm/Down106lm/W	36°	Up4000/Down 4240lm	80

Application ideas

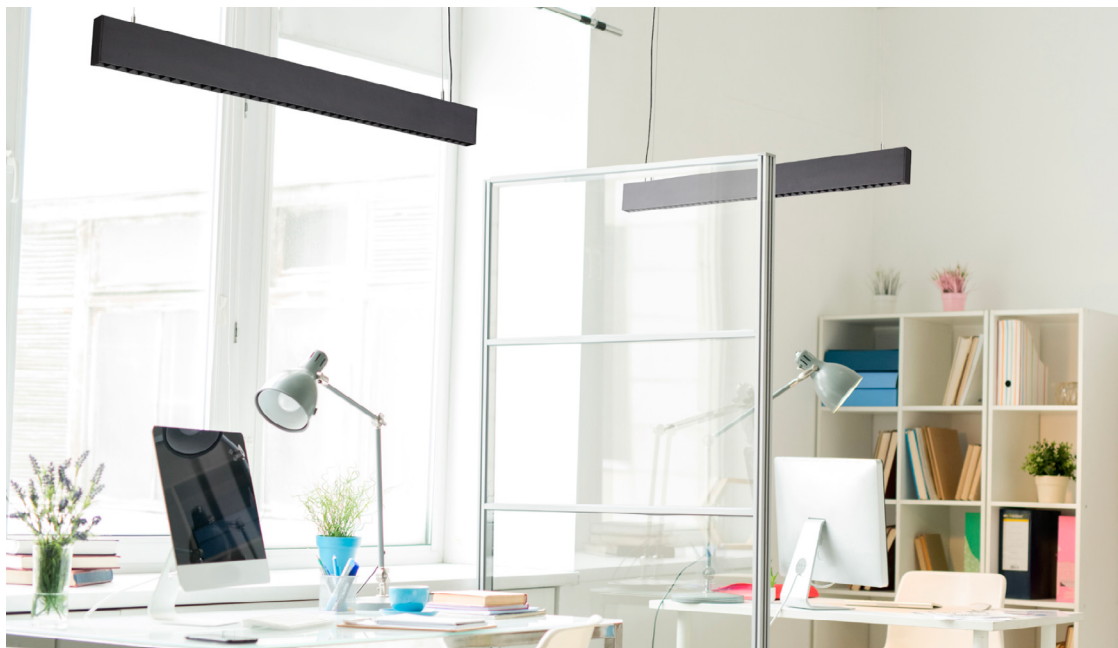

Profile

Profile



IP20

PROFILE W34H100

Product description

High quality aluminum alloy lamp body, can be matched with different optical systems (large angle and polarized lens and various angles of light cups). This product is the perfect choice for your lighting projects: office, conference room, study room, public buildings, libraries,...

Accessories & options

- Cree, Citizen
- Dimmable (Triac, 0-10v)
- Khün, osram, kegu
- DALI
- CRI > 90 or above

Profile W34H100 Opal series

PF34100 Direct light distribution

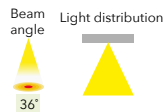

grey black white
 3000K-4000K-6000K
 Size
 34mm
 100mm

PF34100 - Input voltage AC220-240V Multivoltage

Length	Input Power	Lm/W	Beam angle	Luminous flux	CRI
573mm	15W	76lm/W	91°	1095lm	80
853mm	22W	76lm/W	91°	1460lm	80
1133mm	30W	76lm/W	91°	2200lm	80
1413mm	38W	76lm/W	91°	2774lm	80
1693mm	45W	76lm/W	91°	3285lm	80
1973mm	52W	76lm/W	91°	3796lm	80
2253mm	60W	76lm/W	91°	4380lm	80

PF34100 Double sided light distribution

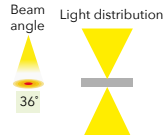

grey black white
 3000K-4000K-6000K
 Size
 34mm
 100mm

PF34100 - Input voltage AC220-240V Multivoltage

Length	Input Power	Lm/W	Beam angle	Luminous flux	CRI
573mm	22W	Up110lm/Down76lm/W	91°	Up679/Down 1095lm	80
853mm	32W	Up110lm/Down76lm/W	91°	Up1067/Down 1460lm	80
1133mm	45W	Up110lm/Down76lm/W	91°	Up1451/Down 2200lm	80
1413mm	57W	Up110lm/Down76lm/W	91°	Up1843/Down 2774lm	80
1693mm	67W	Up110lm/Down76lm/W	91°	Up2134/Down 3285lm	80
1973mm	78W	Up110lm/Down76lm/W	91°	Up2522/Down 3796lm	80
2253mm	90W	Up110lm/Down76lm/W	91°	Up2910/Down 4380lm	80

Application ideas

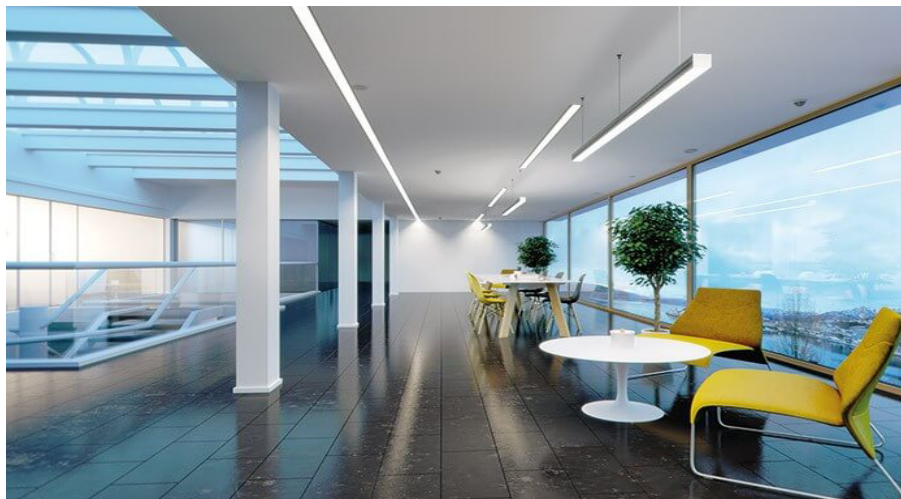

W34H100 opal

W34H100 opal

Profile

Profile



PROFILE W91H91



Product description

Aluminum 6063, good heat radiation with long lifespan, **Waterproof Ip66**, Anti-collision level Ik10 Support 0-1 0V, PWM and Resistor dimming solution, High lighting efficiency, save energy, Long lifespan >=50000 hours; Light source adopts LM-80 certified LED, Adopt UL Class P certified power supply.

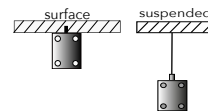
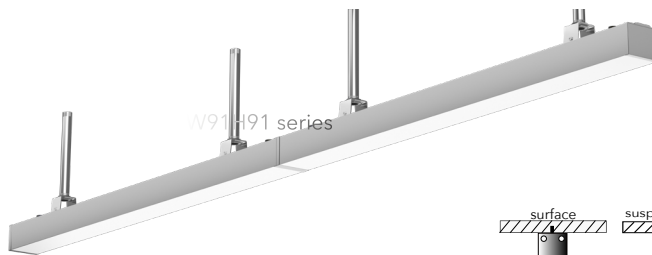

Accessories & options

- Cree, Citizen
- Dimmable (Triac, 0-10v)
- Khün, osram, kegu
- DALI
- CRI > 90 or above

Profile W91H91 Ip66 series

PF9191.45 Direct light distribution

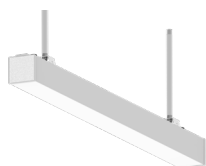
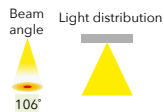

3000K-4000K-6000K
grey black white

Size
91mm (3.58")
91mm (3.58")

Linkable

PF9191.45 - Input voltage AC220-240V Multivoltage

Length	Input Power	Lm/W	Beam angle	Luminous flux	CRI
1237mm	45W	107lm/W	106°	4857lm	80

PF9191.90 Direct light distribution

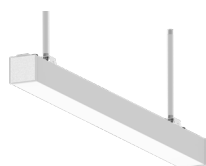
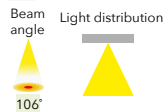

3000K-4000K-6000K
grey black white

Size
91mm (3.58")
91mm (3.58")

Linkable

PF9191.90 - Input voltage AC220-240V Multivoltage

Length	Input Power	Lm/W	Beam angle	Luminous flux	CRI
2456mm	90W	107lm/W	106°	9713lm	80

Connection solution

linkable set straight connector



PF9191-LK



electrical connection cable

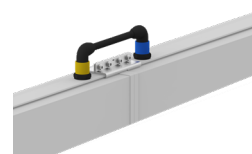

Application ideas

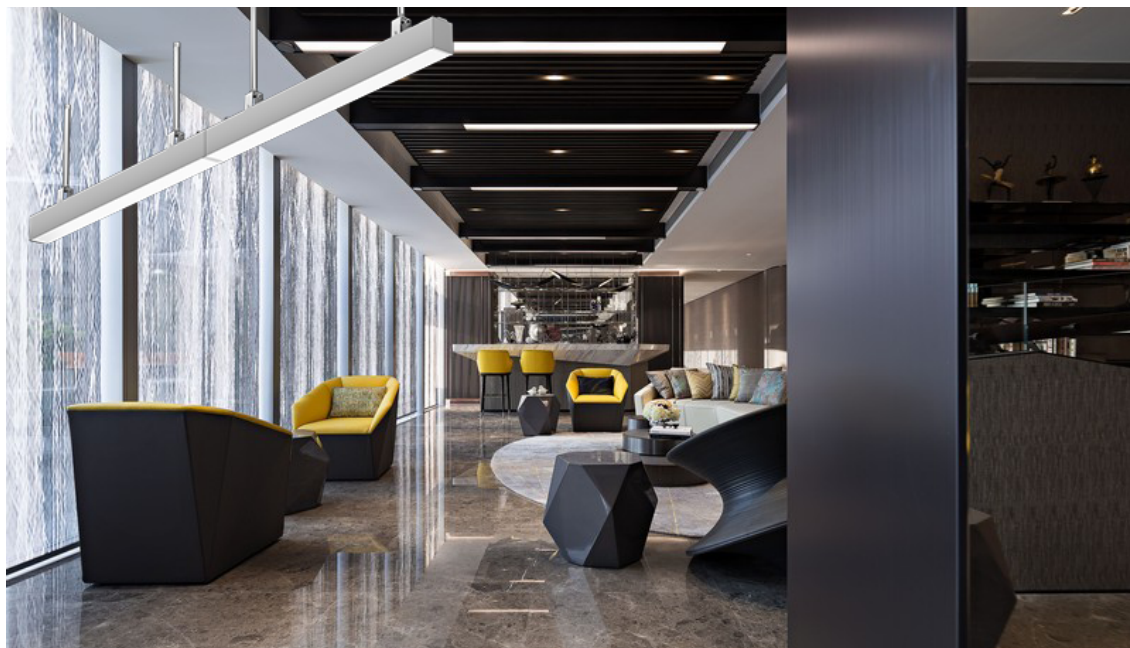

Profile

Profile

THANK YOU



Thank you for your attention any enquiry feel free to contact us.



nelux architectural lighting

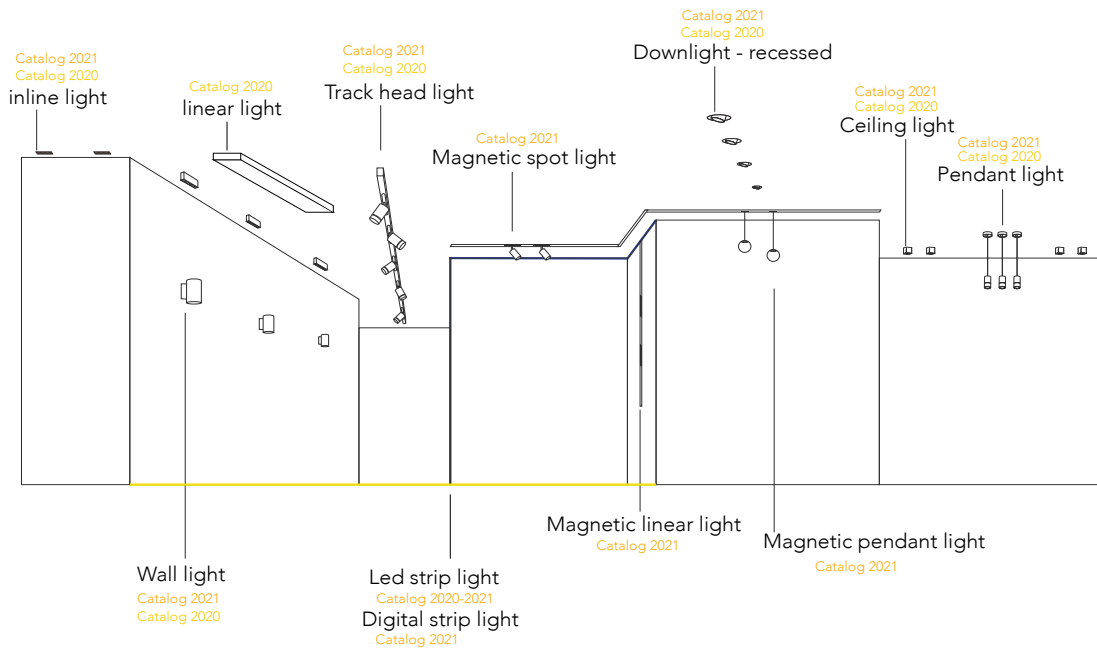



NELUX HK INTERNATIONAL,LTD aporta al mundo del diseño de iluminación nuevos productos e ideas que puedan dar a los arquitectos, decoradores, interioristas ,lighting designers, etc un amplio abanico de posibilidades para sus proyectos.

Nelux producing your dreams

NELUX HK INTERNATIONAL, LTD brings new products and ideas to the world of lighting design giving to architects, decorators, interior designers, lighting designers, etc. a wide range of possibilities to your projects projects.

Nelux producing your dreams

email
sales@nelux.com.hk
salesnelux@gmail.com
sales01@nelux.com.hk

skype
neluxlighting

wechat
neluxury

instagram
https://www.instagram.com/nelux_hk/